

Nikon

En

The Nikon Guide to Digital Photography
with the

D70s

DIGITAL CAMERA



CE

Product Documentation

The documentation for this product includes the manuals listed below. Please be sure to read all instructions thoroughly to get the most from your camera.

Quick Start Guide

The *Quick Start Guide* takes you through the process of unpacking and setting up your Nikon digital camera, taking your first photographs, and transferring them to your computer.

Guide to Digital Photography

The *Guide to Digital Photography* (this manual) provides complete operating instructions for your camera.

PictureProject Reference Manual (on CD)

The *PictureProject Reference Manual* contains information on using the PictureProject software provided with your camera. For information on viewing the reference manual, see the *Quick Start Guide*.

CAUTION: Foreign Matter on the Low-Pass Filter

Nikon takes every possible precaution to prevent foreign matter from coming into contact with the low-pass filter during production and shipping. The D70S, however, is designed to be used with interchangeable lenses, and foreign matter may enter the camera when lenses are removed or exchanged. Once inside the camera, this foreign matter may adhere to the low-pass filter, where it may appear in photographs taken under certain conditions. To prevent foreign matter from entering the camera, do not exchange lenses in dusty environments. To protect the camera when no lens is in place, be sure to replace the body cap provided with the camera, being careful to first remove all dust and other foreign matter that may be adhering to the body cap.

Should foreign matter find its way onto the low-pass filter, clean the low-pass filter as instructed on pages 194–195 of this manual, or have the low-pass filter cleaned by authorized Nikon service personnel. Photographs affected by the presence of foreign matter on the low-pass filter can be retouched using Nikon Capture 4 version 4.2 or later (available separately) or the clean image options available in some third-party imaging software.

How to Read This Manual

First, be aware of the warnings, cautions, and notices on pages ii–v.

Next, read “Overview” and “Getting to Know the Camera” to familiarize yourself with the conventions used in this manual and the names of camera parts, then set up your camera as described in “First Steps.”

Now you are ready to take photographs and play them back. You can then try your hand at creative composition as described in “Digital Vari-Programs.”

Once you have mastered the basics of digital photography, you can read these sections for complete information on when and how to use camera controls.

Refer to these chapters for more on playback...

...on camera menus and custom settings...

...on connecting to a computer or TV...

...on printing photos on a PictBridge printer...

...and on accessories and troubleshooting.

Overview



Getting to Know the Camera



First Steps



Basic Photography



Basic Playback



Digital Vari-Programs



Image Quality and Size



Sensitivity (ISO Equivalency)



White Balance



Optimizing Images



Choosing a Shooting Mode



Focus



Exposure



Flash Photography



Self-Timer Mode



Using the Remote Control



Two-Button Reset



More About Playback



Menu Guide



Connections



Printing Photographs



Technical Notes



For Your Safety







To prevent damage to your Nikon product or injury to yourself or to others, read the following safety precautions in their entirety before using this equipment. Keep these safety instructions where all those who use the product will read them.

The consequences that could result from failure to observe the precautions listed in this section are indicated by the following symbol:



This icon marks warnings, information that should be read before using this Nikon product to prevent possible injury.

WARNINGS

-  **Do not look at the sun through the viewfinder**
Viewing the sun or other strong light source through the viewfinder could cause permanent visual impairment.
-  **Turn off immediately in the event of malfunction**
Should you notice smoke or an unusual smell coming from the equipment or from the AC adapter (available separately), unplug the AC adapter and remove the battery immediately, taking care to avoid burns. Continued operation could result in injury. After removing the battery, take the equipment to a Nikon-authorized service center for inspection.
-  **Do not use in the presence of flammable gas**
Do not use electronic equipment in the presence of flammable gas, as this could result in explosion or fire.
-  **Do not place strap around the neck of an infant or child**
Placing the camera strap around the neck of an infant or child could result in strangulation.
-  **Do not disassemble**
Touching the product's internal parts could result in injury. In the event of a malfunction, the product should be repaired only by a qualified technician. Should the product break open as the result of a fall or other accident, remove the battery and/or AC adapter and then take the product to a Nikon-authorized service center for inspection.
-  **Observe proper precautions when handling batteries**
Batteries may leak or explode if improperly handled. Observe the following precautions when handling batteries for use in this product:
 - Be sure the product is off before replacing the battery. If you are using an AC adapter, be sure it is unplugged.
 - Use only batteries approved for use in this equipment. Do not mix old and new batteries or batteries of different types.
 - Do not attempt to insert the battery upside down or backwards.
 - Do not short or disassemble the battery.
 - Do not expose the battery to flame or to excessive heat.
 - Do not immerse in or expose to water.

- Replace the terminal cover when transporting the battery. Do not transport or store with metal objects such as necklaces or hairpins.
- Batteries are prone to leakage when fully discharged. To avoid damage to the product, be sure to remove the battery when no charge remains.
- When the battery is not in use, attach the terminal cover and store in a cool place.
- Immediately after use, or when the product is used on battery power for an extended period, the battery may become hot. Before removing the battery, turn the camera off and allow the battery to cool.
- Discontinue use immediately should you notice any changes in the battery, such as discoloration or deformation.

Use appropriate cables

When connecting cables to the input and output jacks, use only the cables provided or sold by Nikon for the purpose, to maintain compliance with product regulations.

Keep out of reach of children

Particular care should be taken to prevent infants from putting the battery or other small parts into their mouths.

Removing memory cards

Memory cards may become hot during use. Observe due caution when removing memory cards from the camera.

CD-ROMs

The CD-ROMs on which the software and manuals are distributed should not be played back on audio CD equipment. Playing CD-ROMs on an audio CD player could cause hearing loss or damage the equipment.

Observe caution when using the flash

- Do not operate the flash with the flash window touching a person or object. Failure to observe this precaution could result in burns or fire.
- Using the flash close to your subject's eyes could cause temporary visual impairment. Particular care should be observed if photographing infants, when the flash should be no less than one meter (39") from the subject.

When using the viewfinder

When operating the diopter adjustment control with your eye to the viewfinder, care should be taken not to put your finger in your eye accidentally.

Avoid contact with liquid crystal

Should the monitor break, care should be taken to avoid injury due to broken glass and to prevent liquid crystal from the monitor touching the skin or entering the eyes or mouth.

Notices

- No part of the manuals included with this product may be reproduced, transmitted, transcribed, stored in a retrieval system, or translated into any language in any form, by any means, without Nikon's prior written permission.
- Nikon reserves the right to change the specifications of the hardware and software described in these manuals at any time and without prior notice.
- Nikon will not be held liable for any damages resulting from the use of this product.
- While every effort has been made to ensure that the information in these manuals is accurate and complete, we would appreciate it were you to bring any errors or omissions to the attention of the Nikon representative in your area (address provided separately).

Notice for customers in the U.S.A.

Federal Communications Commission (FCC) Radio Frequency Interference Statement

This equipment has been tested and found to comply with the limits for a Class B digital device, pursuant to Part 15 of the FCC rules. These limits are designed to provide reasonable protection against harmful interference in a residential installation. This equipment generates, uses, and can radiate radio frequency energy and, if not installed and used in accordance with the instructions, may cause harmful interference to radio communications. However, there is no guarantee that interference will not occur in a particular installation. If this equipment does cause harmful interference to radio or television reception, which can be determined by turning the equipment off and on, the user is encouraged to try to correct the interference by one or more of the following measures:

- Reorient or relocate the receiving antenna.
- Increase the separation between the equipment and receiver.
- Connect the equipment into an outlet on a circuit different from that to which the receiver is connected.
- Consult the dealer or an experienced radio/television technician for help.

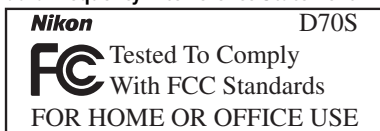

CAUTIONS

Modifications

The FCC requires the user to be notified that any changes or modifications made to this device that are not expressly approved by Nikon Corporation may void the user's authority to operate the equipment.

Interface Cables

Use the interface cables sold or provided by Nikon for your equipment. Using other interface cables may exceed the limits of Class B Part 15 of the FCC rules.

Notice for customers in the State of California

WARNING: Handling the cord on this product will expose you to lead, a chemical known to the State of California to cause birth defects or other reproductive harm.

Wash hands after handling.

Nikon Inc.,
1300 Walt Whitman Road, Melville, New York
11747-3064, U.S.A. Tel.: 631-547-4200

Notice for customers in Canada

CAUTION

This class B digital apparatus meets all requirements of the Canadian Interference Causing Equipment Regulations.

ATTENTION

Cet appareil numérique de la classe B respecte toutes les exigences du Règlement sur le matériel brouilleur du Canada.

Notice Concerning Prohibition of Copying or Reproduction

Note that simply being in possession of material that has been digitally copied or reproduced by means of a scanner, digital camera or other device may be punishable by law.

• Items prohibited by law from being copied or reproduced

Do not copy or reproduce paper money, coins, securities, government bonds, or local government bonds, even if such copies or reproductions are stamped "Sample."

The copying or reproduction of paper money, coins, or securities which are circulated in a foreign country is prohibited.

Unless the prior permission of the government has been obtained, the copying or reproduction of unused postage stamps or post cards issued by the government is prohibited.

The copying or reproduction of stamps issued by the government and of certified documents stipulated by law is prohibited.

• Cautions on certain copies and reproductions

The government has issued cautions on copies or reproductions of securities issued by private companies (shares, bills, checks, gift certificates, etc.), commuter passes, or coupon tickets, except when a minimum of necessary copies are to be provided for business use by a company. Also, do not copy or reproduce passports issued by the government, licenses issued by public agencies and private groups, ID cards, and tickets, such as passes and meal coupons.

• Comply with copyright notices

The copying or reproduction of copyrighted creative works such as books, music, paintings, woodcut prints, maps, drawings, movies, and photographs is governed by national and international copyright laws. Do not use this product for the purpose of making illegal copies or to infringe copyright laws.

Trademark Information

Macintosh, Mac OS, and QuickTime are registered trademarks of Apple Computer, Inc. Microsoft and Windows are registered trademarks of Microsoft Corporation. Pentium is a trademark of Intel Corporation. CompactFlash is a trademark of SanDisk Corporation. Microdrive is a registered trademark of Hitachi Global Storage Technologies in the United States and/or other countries. Lexar Media is a trademark of Lexar Media Corporation. PictBridge is a trademark. All other trade names mentioned in this manual or the other documentation provided with your Nikon product are trademarks or registered trademarks of their respective holders.

Table of Contents

For Your Safety	ii
Notices	iv
Introduction	1
Overview	2
Getting to Know the Camera	3
First Steps	13
Attaching the Camera Strap.....	13
Inserting Batteries	14
Basic Setup	16
Attaching Lenses.....	18
Inserting Memory Cards.....	20
Tutorial	23
Basic Photography	24
Step 1—Rotate the Mode Dial to 	24
Step 2—Ready the Camera	24
Step 3—Adjust Camera Settings	26
Step 4—Frame a Photograph	27
Step 5—Focus.....	28
Step 6—Take the Photograph	30
Basic Playback	31
Digital Vari-Programs	32
Taking Photographs	35
When to Use Shooting Options.....	36
Using Camera Menus	39
Image Quality and Size	41
Image Quality	41
Image Size	43
Sensitivity (ISO Equivalency)	46
White Balance	48
Fine-Tuning White Balance	50
Preset White Balance.....	52
Optimizing Images	56
Customizing Image Enhancement Options	57
Choosing a Shooting Mode	62
Focus	64
Focus Mode	64
Focus Area Selection	66
Focus Lock	70
The AF-Assist Illuminator	72
Getting Good Results with Autofocus	73
Manual Focus	74

Exposure	75
Metering.....	75
Exposure Mode.....	76
Autoexposure Lock	84
Exposure Compensation.....	86
Bracketing	87
Flash Photography	94
Flash Sync Modes.....	95
Using the Built-in Speedlight	97
Self-Timer Mode	105
Using a Remote Control	107
Two-Button Reset	111
More About Playback	113
Single-Image Playback.....	114
Photo Information.....	116
Viewing Multiple Images: Thumbnail Playback.....	118
Taking a Closer Look: Playback Zoom	120
Protecting Photographs from Deletion.....	121
Deleting Individual Photographs.....	122
Menu Guide	123
The Playback Menu	124
Delete	124
Playback Fldr.....	126
Rotate Tall.....	126
Slide Show.....	127
Hide Image	129
Print Set.....	130
The Shooting Menu	132
Optimize Image.....	132
Long Exp. NR	133
Image Quality	134
Image Size	134
White Bal.	134
ISO	134
Custom Settings	135
The Setup Menu	155
Folders.....	156
File No. Seq.....	159
Format.....	160
CSM Menu	161
Date	161

LCD Brightness	161
Mirror Lock-Up.....	162
Video Mode.....	162
Language.....	163
Image Comment.....	163
USB	165
Dust Ref Photo.....	166
Firmware Ver.....	167
Image Rotation	168
Connections.....	169
Television Playback	170
Connecting to a Computer.....	171
Printing Photographs.....	175
Technical Notes.....	181
Camera Settings	182
Optional Accessories.....	183
Lenses for the D70S	183
Optional Speedlights.....	186
Other Accessories.....	190
Caring for the Camera.....	193
Troubleshooting.....	198
Specifications	201
Index	206

Introduction

Getting Started

Overview	
 2	
Getting to Know the Camera	
 3–12	
First Steps	
 13–22	

This chapter is divided into the following sections:

Overview

Read this section for a description of how this manual is organized and for an explanation of the symbols and conventions used.

Getting to Know the Camera

Bookmark this section and refer to it for information on the names and functions of camera parts.

First Steps

This section details the steps required to ready the camera for use: inserting the battery and memory card, attaching a lens and camera strap, and setting the date, time, and language.

Thank you for your purchase of a Nikon D70S single-lens reflex (SLR) digital camera with interchangeable lenses. This manual has been written to help you enjoy taking pictures with your Nikon digital camera. Read this manual thoroughly before use, and keep it handy when using the product.

To make it easier to find the information you need, the following symbols and conventions are used:



This icon marks cautions, information that should be read before use to prevent damage to the camera.



This icon marks tips, additional information that may be helpful when using the camera.



This icon marks notes, information that should be read before using the camera.



This icon indicates that more information is available elsewhere in this manual or in the *Quick Start Guide*.



This icon marks settings that can be adjusted using camera menus.



This icon marks settings that can be fine-tuned from the Custom Settings menu.

Take Test Shots

Before taking pictures on important occasions (for example, at weddings or before taking the camera with you on a trip), take a test shot to ensure that the camera is functioning normally. Nikon will not be held liable for damages or lost profits that may result from product malfunction.

Life-Long Learning

As part of Nikon's "Life-Long Learning" commitment to ongoing product support and education, continually-updated information is available on-line at the following sites:

- For users in the U.S.A.: <http://www.nikonusa.com/>
 - For users in Europe: <http://www.europe-nikon.com/support>
 - For users in Asia, Oceania, the Middle East, and Africa: <http://www.nikon-asia.com/>
- Visit these sites to keep up-to-date with the latest product information, tips, answers to frequently-asked questions (FAQs), and general advice on digital imaging and photography. Additional information may be available from the Nikon representative in your area. See the URL below for contact information:

<http://nikonimaging.com/>

Replacing This Manual

Should you lose this manual, replacements can be ordered, for a fee, from any authorized Nikon service representative.

Getting to Know the Camera

Camera Controls and Displays

Take a few moments to familiarize yourself with camera controls and displays. You may find it helpful to bookmark this section and refer to it as you read through the rest of the manual.

Camera Body

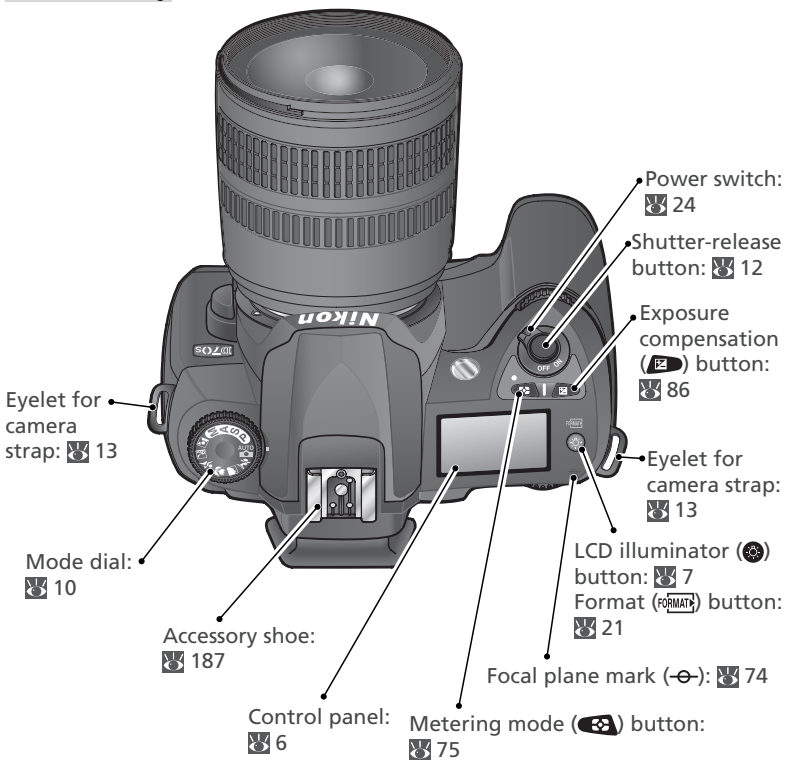



Camera Body (continued)

Self-timer lamp:

105, 107

AF-assist illuminator:

72

Red-eye reduction lamp:

95

Built-in Speedlight:

94

Speedlight lock release (⚡) button: 97

Flash sync mode (⚡) button: 97

Flash exposure compensation (⚡) button: 102

Infrared receiver: 107

Remote cord connector (under cover): 191

DC-in connector (under cover): 170

Video connector (under cover): 170

Lens release button: 19

Focus-mode selector: 64

USB connector (under cover): 171

Sub-command dial:

147

Depth-of-field preview button: 76

Battery-chamber cover:

14

Battery-chamber cover latch:

14

Tripod socket

Reset switch: 200

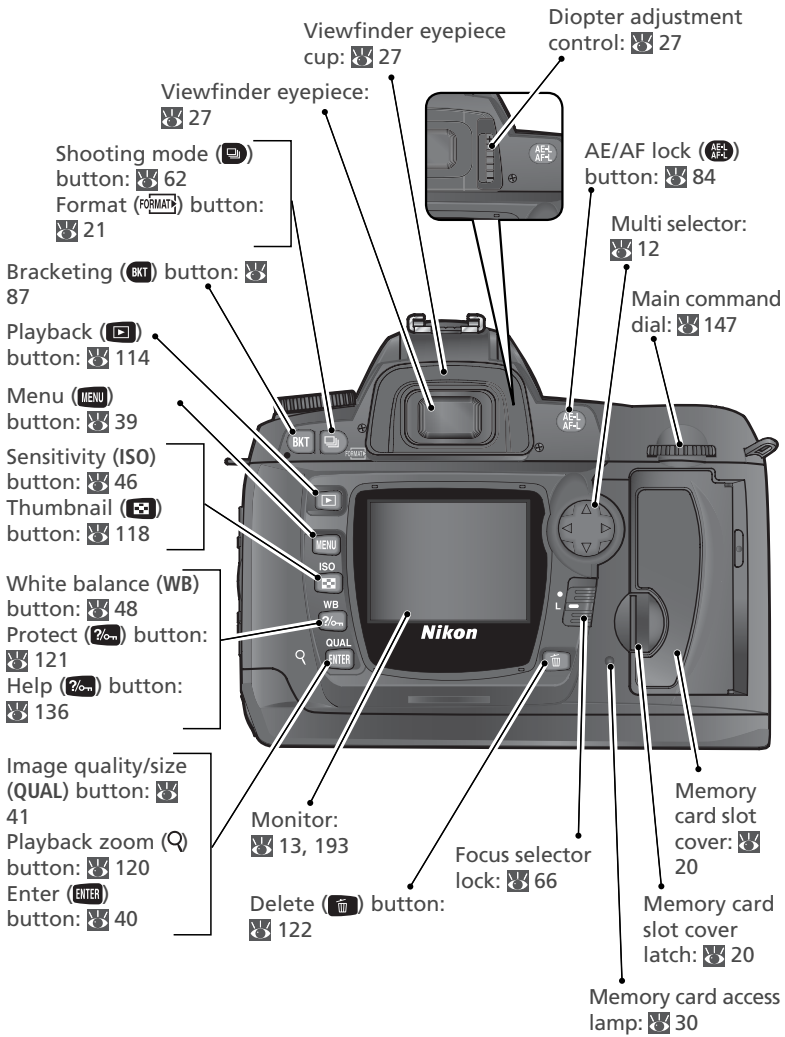



Control Panel

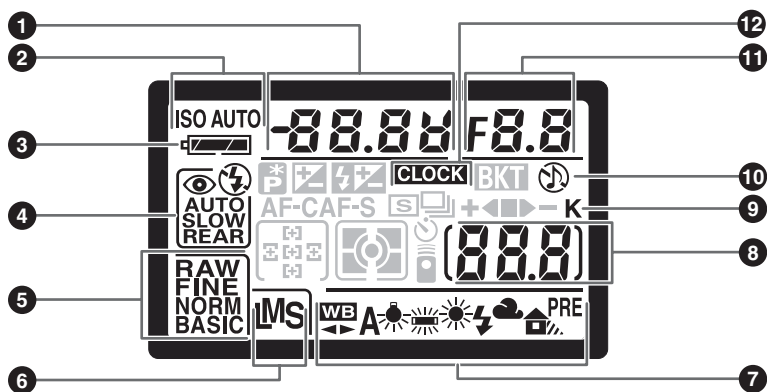

1	Shutter speed	76	8	Number of exposures remaining	25
	Exposure compensation value	86		Number of shots remaining before memory buffer fills.....	62
	Flash compensation value	102		Preset white balance recording indicator	52
	White balance adjustment	50		Remote control mode indicator...	107
	Number of shots in bracketing sequence	87	9	"K" (appears when memory remains for over 1000 exposures)	45
2	Sensitivity (ISO) indicator	46	10	"Beep" indicator	138
	Auto sensitivity indicator	142	11	Aperture (f-number)	76
3	Battery indicator	24		Bracketing increment	87
4	Flash sync mode	95		PC mode indicator	172
5	Image quality	41	12	Clock battery indicator	16
6	Image size	43			
7	White balance mode	48			

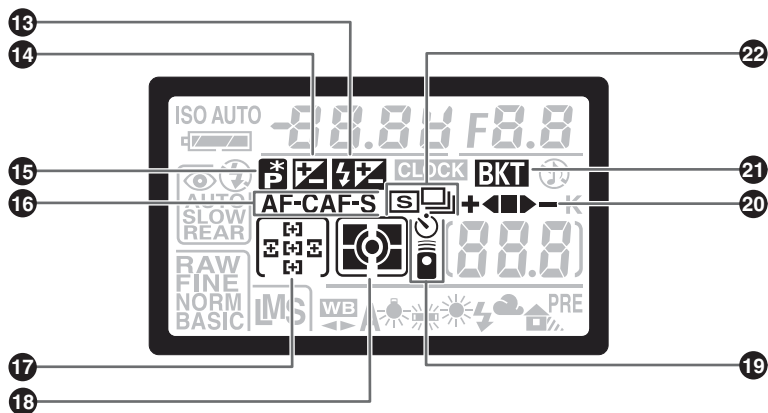

13	Flash compensation indicator.....	102	18	Metering mode.....	75
14	Exposure compensation indicator..	86	19	Self-timer indicator	105
15	Flexible program indicator.....	77		Remote control indicator	107
16	Autofocus mode.....	139	20	Bracketing progress indicator	87
17	Focus area	66	21	Bracketing indicator	87
	AF-area mode.....	140	22	Shooting mode.....	62

LCD Illuminator

Pressing the  button activates the control panel backlight (LCD illuminator), allowing the display to be read in the dark.



The Viewfinder Display

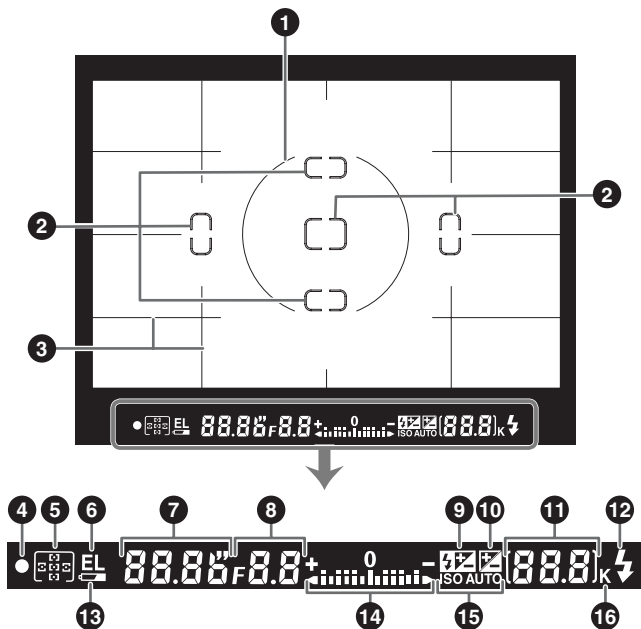

Advanced Focusing Screen Display

When the background is bright, the active focus area (66) is highlighted in black. When the background is dark, the active focus area is highlighted briefly in red as needed to establish contrast with the background (“Vari-Brite” focus areas), making it easier to identify the selected focus area. The viewfinder is also equipped with on-demand grid lines. When **On** is selected for Custom Setting 8 (**Grid display**; 144), a reference grid is superimposed over the display in the viewfinder. This grid is a useful aid when composing landscape shots or when tilting or shifting a PC Nikkor lens.

Owing to the characteristics of this type of viewfinder display, you may notice fine lines radiating outwards from the selected focus area, or that the display in the viewfinder turns red when the selected focus area is highlighted. These phenomena are normal and do not indicate a malfunction.



1	8-mm (0.31") reference circle for center-weighted metering.....	75
2	Focus brackets (focus areas).....	66
	Spot metering targets.....	75
3	Reference grid (displayed when On is selected for Custom Setting 8)....	144
4	Focus indicator	28
5	Focus area	66
	AF-area mode.....	140
6	Autoexposure (AE) lock.....	84
	FV lock indicator	103
7	Shutter speed	76
8	Aperture (f/-number)	76
9	Flash compensation indicator.....	102
10	Exposure compensation indicator..	86
11	Number of exposures remaining	25
	Number of shots remaining before memory buffer fills.....	62
	Preset white balance recording indicator	52
	Exposure compensation value	86
	Flash compensation value	102
	PC mode indicator	172
12	Flash-ready indicator	97
13	Battery indicator	24
14	Electronic analog exposure display	82
	Exposure compensation	86
15	Auto sensitivity indicator.....	142
16	"K" (appears when memory remains for over 1000 exposures)	45

The Viewfinder Display

The focus-area and grid-line displays in the viewfinder (advanced focusing screen display) tend to brighten at high temperatures and to darken and exhibit slower response times at low temperatures. The other displays in the viewfinder tend to darken at high temperatures and exhibit slower response times at low temperatures. All displays will return to normal at room temperature.

No Battery

When the battery is totally exhausted or no battery is inserted, the display in the viewfinder will dim. This is normal and does not indicate a malfunction. The viewfinder display will return to normal when a fully-charged battery is inserted.



The Mode Dial

In addition to Digital Vari-Programs that allow settings to be adjusted to suit a particular scene simply by rotating the mode dial to the appropriate mode, the D70S is equipped with exposure modes that offer complete control over settings.

Digital Vari-Programs

Selecting a Digital Vari-Program automatically optimizes settings to suit the selected scene, making creative photography as simple as rotating the mode dial.

Auto (32)

Use for “point-and-shoot” snapshots that leave the camera in charge of settings. Recommended for first-time users of digital SLR cameras.

Portrait (32)

Shoot portraits with the background in soft focus.

Landscape (32)

Preserve details in landscape shots.

Close Up (33)

Take close-ups of flowers, insects, or other small objects.

Sports (33)

Freeze motion in sports shots.

Night Landscape (33)

Use when taking landscape shots at night.

Night Portrait (34)

Shoot portraits against a dimly-lit backdrop.







Exposure Modes

Select these modes for full control over camera settings, including shutter speed and aperture, flash mode, and camera menus.

P Auto Multi Program 77

Let the camera optimize exposure to suit the subject. Use flexible program to control shutter speed and aperture  77), or adjust exposure with exposure compensation  86).

S Shutter-Priority Auto 79

Choose fast shutter speeds to freeze action, slow shutter speeds to suggest motion by blurring moving objects.

A Aperture-Priority Auto 81

Adjust aperture to soften background details, or increase depth of field to bring both the main subject and the background into focus.

M Manual 82

Match shutter speed and aperture to your creative intent.



Navigating the Menus

The multi selector is used to navigate through the camera menus.

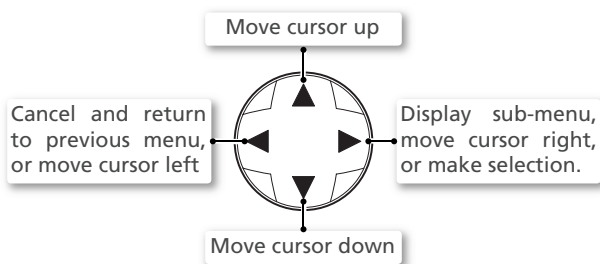

The Shutter-Release Button

The camera has a two stage shutter-release button. The camera sets focus and exposure when the button is pressed halfway. To take the picture, press the shutter-release button the rest of the way down.

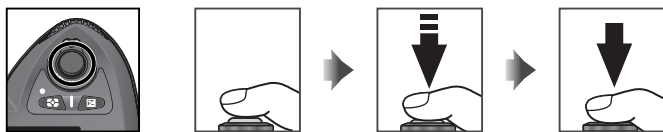

The Multi Selector

The **ENTER** button can also be used to select items highlighted in the camera menus. There may be some cases in which the operations listed on this page do not apply.

Auto Meter Off

At default settings, the camera continues to meter exposure for six seconds after you remove your finger from the shutter-release button. The shutter speed and aperture indicators in the control panel and all indicators in the viewfinder then turn off to save power (auto meter off). The length of the auto meter off delay can be adjusted using Custom Setting 23 (**Meter-off**; 153).

Attaching the Camera Strap

Attach the camera strap securely to the two eyelets on the camera body as shown below.

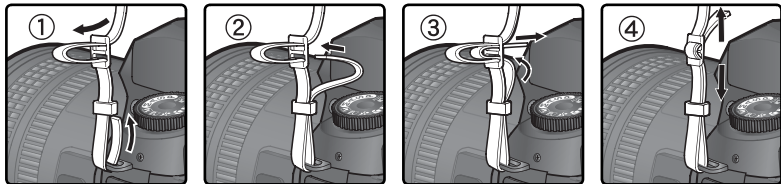

The Monitor Cover

A clear plastic cover (the BM-5 LCD monitor cover) is provided with the camera to keep the monitor clean, and to protect the monitor when the camera is not in use or when you are transporting the camera. To remove the monitor cover, hold the camera firmly and pull the bottom of the cover gently outwards as shown at right (1). Once the cover is unlatched, you can move it slightly away from the monitor (2) and then remove it as shown (3).

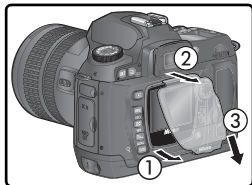

To replace the cover for shooting or storage, insert the two projections on the top of the cover into the matching indentations above the camera monitor (1), then press the bottom of the cover until you hear it click into place (2).

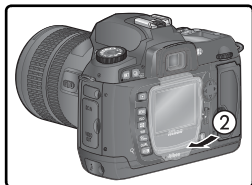
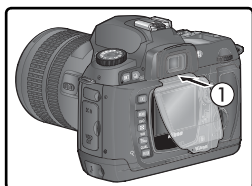



Inserting Batteries

The D70S uses a rechargeable EN-EL3a Li-ion battery (supplied). Charge the battery before first use or after long periods of disuse (see the charger manual for details). About two hours are required to recharge a fully-discharged battery.

1 Turn the camera off

Turn the camera off before inserting or removing batteries.



2 Open the battery-chamber cover

Slide the battery-chamber cover latch to the  position (1) and open the battery-chamber cover (2).

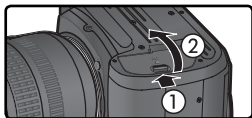

3 Insert the battery

Insert the battery as shown at right.

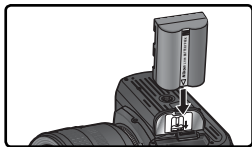

4 Latch the battery-chamber cover

To prevent the battery from being dislodged during operation, be sure the cover is securely latched.

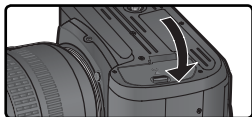

✓ Read Battery Warnings

Read and follow the warnings and cautions on pages ii–iii and 196–197 of this manual, together with any warnings and instructions provided by the battery manufacturer.

✎ Removing Batteries

Before removing batteries, turn the camera off and slide the battery-chamber cover latch to the open position (). Replace the terminal cover when the EN-EL3a is not in use.

**Using the Optional MS-D70 CR2 Lithium Battery Holder**

When inserted in the MS-D70 battery holder (available separately), CR2 lithium batteries can be used as a backup power source in place of the EN-EL3a. CR2 batteries are however suited to use at a restricted range of temperatures. Read the following notice before using CR2 batteries.

Using CR2 Lithium Batteries**Note the following when using CR2 lithium batteries:**

The capacity of CR2 batteries drops sharply when the ambient temperature is below 20°C (68°F).

Operation has been confirmed with the following CR2 lithium batteries:

SANYO CR2 lithium batteries	Toshiba CR2 lithium batteries
Maxell CR2 lithium batteries	Energizer CR2 lithium batteries

The capacity of the above batteries may vary with storage conditions; in some cases, they may cease to function before their expiry date. The presence of fingerprints or other foreign matter on the battery terminals or on the battery contacts inside the holder can also affect battery performance; clean the terminals and contacts with a dry cloth before use.

Place three CR2 batteries in the MS-D70 battery holder as shown in the illustration on the holder and insert the holder in the battery chamber as described on the previous page. CR2 batteries can not be recharged.

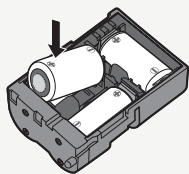



Basic Setup

The first time the camera is turned on, the language selection dialog shown in Step 1 will be displayed in the monitor and the **CLOCK** icon will flash in the control panel. Follow the steps below to choose a language and set the time and date.

1



Language selection dialog displayed.

2



Select language.

3



Display DATE menu.

4



Edit Year, Month, Day, Hour, Minute, and Second. Press multi selector left or right to select item, up or down to change.

5



Exit DATE menu. Monitor turns off.

Basic Setup

If the **ENTER** button is not pressed at the completion of basic setup, the language selection dialog will be displayed the next time the camera is turned on. Until setup is complete, the **CLOCK** icon will continue to flash, and no photographs can be taken nor other operations performed.

The Clock Battery

The clock-calendar is powered by an independent, rechargeable power source, which is charged as necessary when the main batteries are installed or the camera is powered by an optional EH-5 AC adapter. Three days of charging will power the clock for about one month. If the **CLOCK** icon flashes in the control panel, the clock battery is exhausted and the clock has been reset to 2005.01.01 00:00:00. Set the clock to the correct date and time as described in “The Setup Menu: Date”  161).

The Camera Clock

The camera clock is less accurate than most watches and household clocks. Check the clock regularly against more accurate time pieces and reset as necessary.

Language 163

To change the language in which camera menus and messages are displayed, use the **Language** option in the setup menu.

Date 161

Use the **Date** option in the setup menu to change the time and date.



Attaching Lenses

Nikon recommends using a type G or type D CPU lens to take full advantage of the features the camera offers.

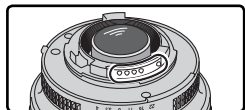

CPU lenses have CPU contacts

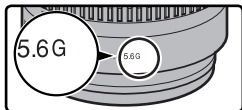

Type G lens



Type D lens

1 Turn the camera off

Turn the camera off before attaching or removing lenses.



2 Attach a lens

Keeping the mounting mark on the lens aligned with the mounting mark on the camera body, position the lens in the camera's bayonet mount. Being careful not to press the lens-release button, rotate the lens counter-clockwise until it clicks into place.

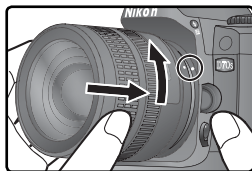

3 Lock aperture at the minimum setting

This step is not necessary if you are using a type G lens not equipped with an aperture ring. If you are using a lens of another type, lock aperture at the minimum setting (highest f/-number).

If this step is omitted when attaching a CPU lens, the aperture displays in the control panel and viewfinder will show a blinking **FE E** when the camera is turned on. Photographs can not be taken until the camera is turned off and aperture locked at the highest f/-number.

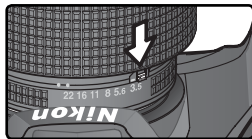
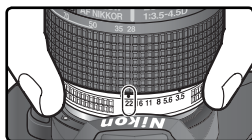



✔ Protect the Camera from Dirt and Dust

Any dust, dirt, or other foreign matter inside your camera could show up as specks or blotches in your photographs or the viewfinder display. When no lens is in place, keep the lens mount covered with the supplied body cap. When exchanging lenses or replacing the body cap, keep the lens mount pointed down.

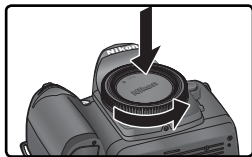

✍ Detaching Lenses

Be sure the camera is off when removing or exchanging lenses. To remove the lens, press and hold the lens-release button while turning the lens clockwise.

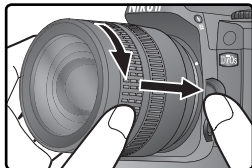



Inserting Memory Cards

In place of film, the D70S uses CompactFlash or microdrive memory cards to store photographs. For a list of approved memory cards, see “Technical Notes: Approved Memory Cards” (📖 192).

1 Turn the camera off

Turn the camera off before inserting or removing memory cards.



2 Open the card slot cover

Open the card slot cover as shown at right.

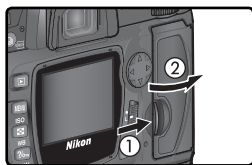

3 Insert a memory card

Insert the memory card with the rear label toward the monitor (①). When the memory card is fully inserted, the access lamp will light and the eject button will pop up (②). Close the card slot cover.

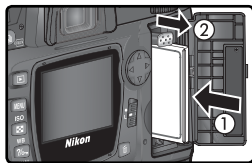

✓ Inserting Memory Cards

Insert the memory card terminals first. Inserting the card upside down or backwards could damage the camera or the card. Check to be sure that the card is in the correct orientation.

The memory card slot is on a slight angle (see illustration at right). Match the angle of the memory card slot when inserting cards.

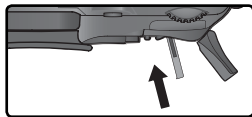
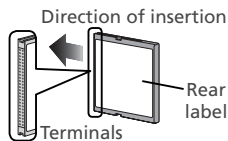



4 Format the memory card

Memory cards must be formatted before first use.

✓ Formatting Memory Cards

Formatting memory cards permanently deletes any data they may contain. Be sure to copy any photographs and other data you wish to keep to a computer before proceeding (📄 171–174).

To format the card, turn the camera on and hold the **FORMAT** (📄) and **⊙** buttons down simultaneously for approximately two seconds. A blinking **F o r** will appear in the shutter-speed display and the frame count will blink. Pressing both buttons together a second time will format the memory card. Press any other button to exit without formatting.

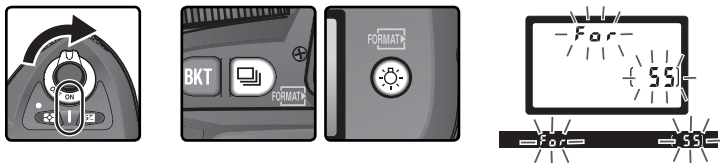

During formatting, the letters **F o r** will be appear in the frame-count display. When formatting is complete, the frame-count display will show the number of photographs that can be recorded at current settings.

✓ During Formatting

Do not remove the card or battery or unplug the AC adapter (available separately) during formatting.

📄 Format (📄 160)

Memory cards can also be formatted using the **Format** option in the setup menu.

✓ Removing Memory Cards

Memory cards can be removed without loss of data when the camera is off. Before removing the memory card, wait for the green card access lamp next to the card slot cover to go out and then turn the camera off. **Do NOT attempt to remove the card while the access lamp is on.** Failure to observe this precaution could result in loss of data or in damage to the camera or card. Open card slot cover and press the eject button to partially eject the card (①). The card can then be removed by hand (②). Do not push on the memory card while pressing the eject button. Failure to observe this precaution could damage the memory card.

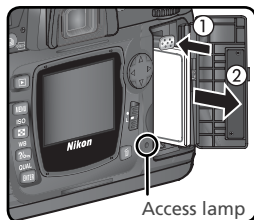

Note that memory cards may be hot after use. Observe due caution when removing memory cards from the camera.

⊗ No Memory Card

If no memory card is inserted in the camera when charged batteries are in place or the camera is powered by an AC adapter, [-E-] will appear in the exposure-count display.



Tutorial

Basic Photography and Playback

Basic Photography

 24–30



Basic Playback

 31



Digital Vari-Programs







 32–34



This chapter is divided into the following sections:

Basic Photography

This section details how to use the  (auto) Digital Vari-Program for “point-and-shoot” photography that produces optimal results in most situations.

Step 1	Rotate the Mode Dial to 	 24
Step 2	Ready the Camera	 24–25
Step 3	Adjust Camera Settings	 26
Step 4	Frame the Photograph	 27
Step 5	Focus	 28–29
Step 6	Take the Photograph	 30

Basic Playback

Read this section for information on viewing photographs in the monitor.

Digital Vari-Programs

This section describes other Digital Vari-Programs that leave the camera in charge of settings while allowing you to express your creativity with a variety of subject types.

Step 1—Rotate the Mode Dial to

Rotate the mode dial to . In this automatic, “point-and-shoot” mode, the majority of settings are controlled by the camera in response to shooting conditions, making it ideal for first-time users of digital SLR cameras.

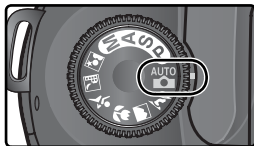

Step 2—Ready the Camera

Before taking photographs, ready the camera as described below.

2.1 Turn the camera on







The control panel will turn on and the display in the viewfinder will light.

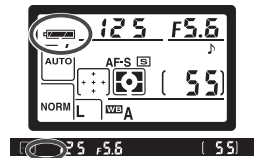

2.2 Check the battery level

Check the battery level in the viewfinder or control panel.



Icon*		Status	Notes
Control panel	Viewfinder		
	—	Battery fully charged	Aperture and shutter-speed indicators in control panel and all indicators in viewfinder turn off if no operations are performed for 6s (auto meter off). Press shutter-release button halfway to reactivate display.
	—	Battery partially discharged	
		Low battery	Ready fully-charged spare battery.
 (flashes)	 (flashes)	Battery exhausted	Shutter release disabled.

* No icon displayed when camera powered by optional AC adapter.

2.3 Check the number of exposures remaining

The exposure-count displays in the control panel and viewfinder show the number of photographs that can be taken at current settings. When this number reaches zero,  will flash in the exposure-count displays, while the shutter-speed displays will show a blinking **FULL** or **Ful**. No further pictures can be taken until you delete pictures or insert a new memory card. You may be able to take additional pictures at lower image quality or size settings.

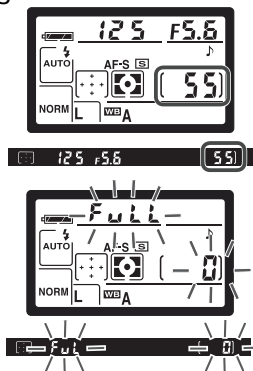

Non-CPU Lenses

Digital Vari-Program modes (including  mode) are available only with CPU lenses. The shutter release is disabled when a non-CPU lens is attached. See “Optional Accessories: Lenses for the D70S” ( 183).

CR2 Batteries

Depending on the type of battery and on battery use, the camera may require more time to update the exposure-count display when CR2 batteries are used.

[CH]A



For information on what to do when [CH]A flashes in the exposure-count display, see “Troubleshooting” ( 200).

Camera Off Display

If the camera is turned off with a battery and memory card inserted, the number of exposures remaining will be displayed in the control panel.



Step 3—Adjust Camera Settings

When the mode dial is rotated to , camera settings are automatically adjusted to produce optimal results in most situations. Image quality, image size, sensitivity, and shooting mode are set to the values in the table below. See “Taking Photographs” ( 35).

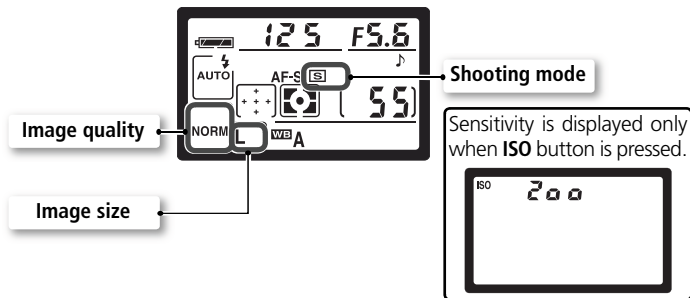

Option	Default	Description	
Image quality	NORM (JPEG Normal)	Pictures are compressed for balance between image quality and file size that is ideal for snapshots.	41–42
Image size	L (Large)	Images are 3,008 × 2,000 pixels in size.	43–45
Sensitivity	200	Sensitivity (digital equivalent of film speed) set to value roughly equivalent to ISO 200.	46–47
Shooting mode	[S] (Single frame)	One photograph is taken each time shutter-release-button is pressed.	62–63

Step 4—Frame a Photograph

Choose a focus mode and frame a photograph.

4.1 Choose autofocus

Confirm that the focus-mode selector is pointing to **AF** (autofocus). At this setting, the camera will focus automatically when the shutter-release button is pressed halfway. Pictures can only be taken when the camera is in focus.



4.2 Frame a photograph

The recommended stance for taking photographs is with one foot a half pace in front of the other and your upper body stable. To prevent blurred photographs caused by unsteady hands (camera shake), hold the camera steadily in both hands, with your elbows propped lightly against your torso for support. Hold the handgrip in your right hand and cradle the camera body or lens with your left.



Viewfinder Frame Coverage

The viewfinder shows slightly less of the image (approximately 95% both vertically and horizontally) than appears in the final photograph.

Viewfinder Focus



The viewfinder is equipped with diopter adjustment to accommodate individual differences in vision. To adjust viewfinder focus, slide the diopter adjustment control up and down until the viewfinder display and focus brackets are in sharp focus. If necessary, the rubber eyepiece cup can be removed; when the cup is replaced, the lettered face should be down.



When operating the diopter adjustment control with your eye to the viewfinder, be careful not to put your fingers or fingernails in your eye.



Diopter can be adjusted in the range -1.6m^{-1} to $+0.5\text{m}^{-1}$. Corrective lenses (available separately; 190) allow diopters of -5m^{-1} to $+3\text{m}^{-1}$.

Step 5—Focus

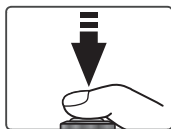
Press the shutter-release button halfway. The camera will automatically select the focus area containing the subject closest to the camera (closest subject priority;  140). Once the camera has focused on this subject, a beep will sound, the selected focus area will be highlighted ( 8), and the in-focus indicator () will appear in the viewfinder (see table below). If the subject moves out of the selected focus area before the camera has focused, the camera will focus based on information from other focus areas.





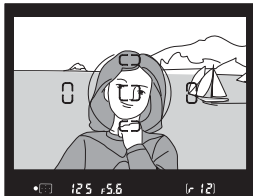

Focus indicator	Description
●	Subject in focus (beep will sound when camera has focused).
● (flashes)	Camera unable to focus using autofocus.

If the subject is dark, the AF-assist illuminator ( 72) will light automatically to assist in the focus operation. To focus on a subject that does not fall in any of the five focus frames, use focus lock ( 70). For information on what to do if the camera is unable to focus using autofocus, see “Getting Good Results with Autofocus” ( 73).

In **AUTO** mode, the camera automatically sets shutter speed and aperture when the shutter-release button is pressed halfway. Before shooting, check the shutter-speed and aperture indicators in the viewfinder. If the photo would be overexposed at current settings, **H** **f** will be displayed; use an optional Neutral Density (ND) filter. If the photo would be underexposed, the built-in Speedlight will pop up automatically, and fire when the photograph is taken.



The Built-in Speedlight

If additional lighting is required for correct exposure in **AUTO**, , , and  modes, the built-in Speedlight will pop up automatically when the shutter-release is pressed halfway ( 94). When the built-in Speedlight is raised, photographs can only be taken when the flash-ready indicator is displayed. If the flash-ready indicator is not displayed, remove your finger briefly from the shutter-release button and try again.

If desired, the flash can be turned off so that it will not fire even when lighting is poor. A red-eye reduction mode is also available for reducing “red-eye” caused by light reflecting from the subject’s retinas ( 95).

When the Speedlight Is Not in Use

To save battery power when the Speedlight is not in use, return it to the closed position by pressing it gently downward until the latch clicks into place.



Flash-ready indicator

Step 6—Take the Photograph

Smoothly press the shutter-release button the rest of the way down.

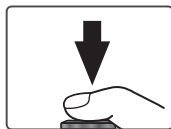

While the photograph is being recorded to the memory card after shooting, it will be displayed in the monitor (see opposite) and the access lamp next to the card slot cover will light. ***Do not eject the memory card, turn the camera off, or remove or disconnect the power source until the lamp has gone out.*** Removing the memory card or cutting power in these circumstances could result in loss of data.

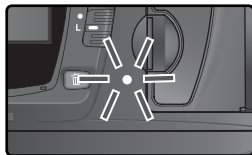
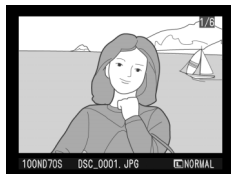

Shutter Sound

The D70S is equipped with a combined electronic (CCD) and mechanical shutter. This shutter operates on a different principle from the mechanical shutters found in film cameras. As a result, the interval between the sounds made by the shutter and mirror will not decrease past a certain point, even at high shutter speeds.

Photographs are displayed automatically while being recorded to the memory card. Photographs can also be viewed by pressing the  button to display most recent photograph in the monitor.

During Recording



Photographs are automatically displayed while being recorded to memory card.



The Button



Press  button at any time to display most recent photograph.

Press the multi selector up or down to view additional photographs. Press the multi selector down to view photographs in the order recorded, up to view photographs in reverse order.

Deleting Unwanted Photographs

To delete the photograph currently displayed in the monitor, press the  button. A confirmation dialog will be displayed. Press the  button again to delete the image and return to playback. Press any other button to exit without deleting the picture.



Take Additional Photographs

To end playback and return to shooting mode, press the  button or press the shutter-release button halfway.

The D70S offers a choice of seven Digital Vari-Program modes. Selecting a program automatically optimizes settings to suit the selected scene, making creative photography as simple as rotating the mode dial.



Digital Vari-Programs are available with CPU lenses only. When a non-CPU lens is attached, the shutter release is disabled. See “Camera Settings” (📖 182) for information on the options available in Digital Vari-Program modes.

Auto

Use for snapshots. Camera settings are automatically adjusted according to subject and lighting, producing vivid, smooth images with balanced saturation, color, and sharpness.

- Flash set to front-curtain sync. Other modes can be selected (📖 96).



Portrait

Use for portraits. Main subject stands out clearly while background details are softened, lending composition sense of depth.

- Degree of softening depends on amount of light available. Increase distance between subject and background or use telephoto lens for best results.
- Flash set to front-curtain sync. Other modes can be selected (📖 96).



Landscape

Use for vivid landscape shots that enhance outlines, colors, and contrast in such subjects as skyscapes and forests.

- Use wide-angle lens for wider field of view.
- Built-in Speedlight and AF-assist illuminator turn off automatically and will not fire even when lighting is poor.



Focus

Except in 📖 mode, the camera automatically selects the focus area containing the subject closest to the camera. Once the camera has focused on this subject, a beep will sound (📖 excepted), the selected focus area will be highlighted (📖 8), and focus will lock. If the subject moves out of the selected focus area before the camera has focused, the camera will focus based on information from other focus areas.

Close up

Use for close-up shots of flowers, insects, and other small objects in which main subject stands out clearly. Reds and greens are captured particularly vividly.



- Camera automatically selects center focus area. Focus area selection can be changed.
- Tripod, self-timer (105) and/or optional ML-L3 remote control (107) or MC-DC1 remote cord (191) can be used to prevent blurring at slow shutter speeds.
- Micro lens recommended. Effective use can be made of other lenses by focusing at minimum focus distance. With zoom lenses, zoom in to make subject appear larger.
- Flash set to front-curtain sync. Other modes can be selected (96).

Sports

High shutter speeds freeze motion for dynamic sports shots in which main subject stands out clearly.



- Camera focus continuously while shutter-release button is pressed halfway, following movement of subject through focus areas. Note that shutter can be released even when camera is not in focus; check focus indicator (●) in viewfinder before shooting.
- Use telephoto lens for best results. Tripod recommended to prevent blurring when telephoto lens is used.
- Built-in Speedlight and AF-assist illuminator turn off automatically and will not fire even when lighting is poor.

Night landscape

Slow shutter speeds produce stunning night landscapes while minimizing mottling and discoloration often seen in low-light photographs.









- Tripod, self-timer (105), and/or optional ML-L3 remote control (107) or MC-DC1 remote cord (191) can be used to prevent blurring at slow shutter speeds. At speeds slower than 1 s, use noise reduction to reduce mottling (133).
- Use mode for portraits that include night scenery.
- Built-in Speedlight and AF-assist illuminator turn off automatically and will not fire even when lighting is poor.

Night portrait

Provides natural balance between main subject and background in portraits taken under low light. Lighting for portrait subject will seem natural even when flash is used.





- Tripod, self-timer () 105), and/or optional ML-L3 remote control () 107) or MC-DC1 remote cord () 191) can be used to prevent blurring at slow shutter speeds. At speeds slower than 1 s, use noise reduction to reduce mottling () 133).
- Use  mode for night shots that do not include portrait subject.
- Flash set to slow sync. Other modes can be selected () 96).

The Remote Cord Connector Cover

To prevent moisture entering via the remote cord connector from damaging the camera, keep the remote cord connector cover closed in wet or humid environments.

Exposure Warning



If the limits of the exposure metering system are exceeded, one of the following indicators will be displayed in the control panel and viewfinder:

Indicator	Description
	Subject too bright. Use optional Neutral Density (ND) filter.
	Subject too dark. Raise sensitivity (ISO equivalency; ) 46).



Color Space

Digital Vari-Program modes use the sRGB color space () 59).

The Self-Timer, Remote Control, and Remote Cord

The self-timer and optional remote accessories can be used to operate the shutter remotely and prevent blur caused by camera shake. At default settings, the self-timer delays shutter release until about ten seconds after the shutter-release button is pressed () 105). The optional ML-L3 remote control offers instantaneous remote release and remote release with a two-second delay () 107), while the optional MC-DC1 remote cord can be used for remote release and features a shutter-release button lock (see the MC-DC1 instruction manual for details).

P, S, A, and M Modes

In addition to the settings available in  mode, P, S, A, and M modes offer control over such settings as shutter speed and aperture, white balance, image optimization, and exposure compensation. See “Taking Photographs” () 35).



Taking Photographs

The Details

“Tutorial: Taking Photographs” described the basic order of operations for taking photographs at the most commonly-used settings. This chapter explains how and when to adjust camera settings for different shooting conditions.

Using Camera Menus

 39–40



Image Quality and Size

 41–45



Sensitivity (ISO Equivalency)

 46–47



White Balance

 48–55



Optimizing Images

 56–61



Choosing a Shooting Mode

 62–63



Focus

 64–74



Exposure

 75–93



Flash Photography

 94–104



Self-Timer Mode

 105–106



Using a Remote Control

 107–110



Two-Button Reset

 111



When to Use Shooting Options

The following figure illustrates when to use the shooting options described in this chapter.

Photos "grainy" when enlarged?

Files too big for e-mail?

Need to get more pictures on a memory card?

Image Quality and Size (📷 41–45)

Choose high settings for quality and size when taking photos that will be enlarged, lower settings when taking photos for electronic distribution or to save space on the memory card.

Shooting Mode (📷 62–63)

Take photographs one at a time or in a continuous burst.

Shutter response too slow?

Photos out of focus?

Focus (📷 64–74)

Give priority to accurate focus or shutter response. Select how focus area is chosen and whether to focus manually or automatically.

Want to shoot a self-portrait?

Photos blurred by camera shake?

Self-Timer (📷 105–106)

Delay shutter release until after the shutter-release button is pressed.

Remote Control (📷 107–110)

Use the optional remote control for taking photos at a distance.

Want to shoot at default settings?

Two-Button Reset (📷 111)

Reset shooting options to default values.

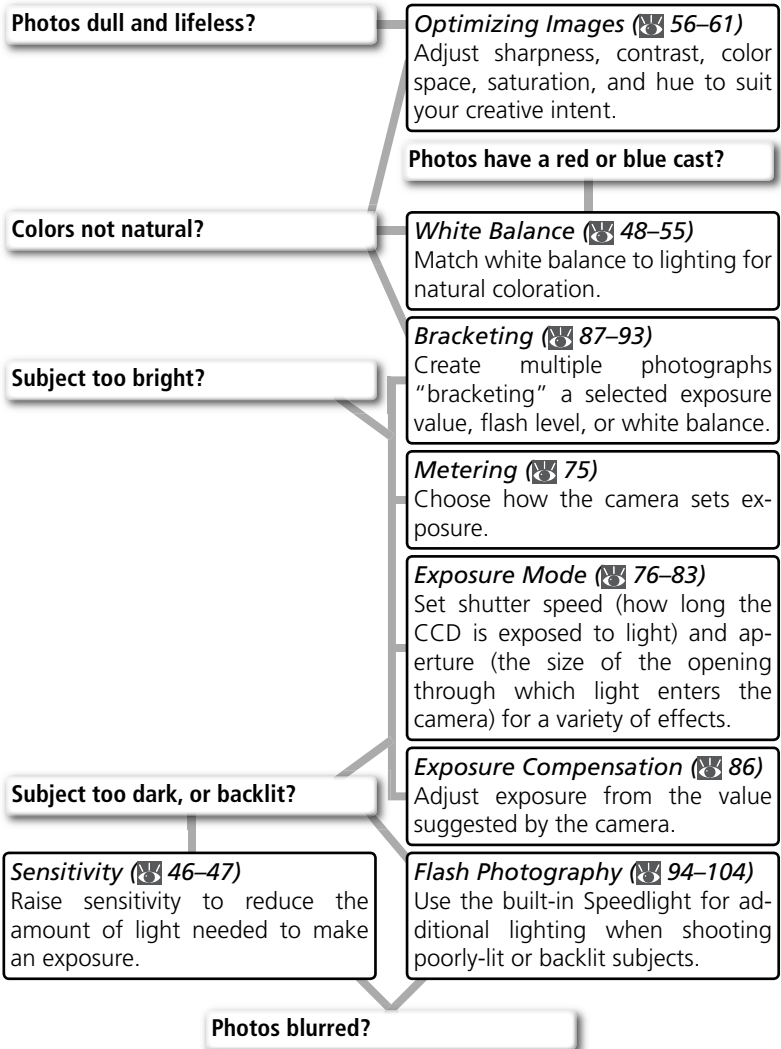

The chart below shows the basic order for adjusting settings when taking photographs. Before proceeding, be sure to read “Using Camera Menus” (📖 39) for information on menu operations.

How will this photograph be used?		
➔	Image Quality and Size.....📖	41–45
➔	Optimizing Images.....📖	56–61
➔	The Shooting Menu.....📖	132–134
What lighting is available?		
➔	Sensitivity (ISO Equivalency).....📖	46–47
➔	White Balance.....📖	48–55
Will this be a single photo, or a series of photos?		
➔	Choosing a Shooting Mode.....📖	62–63
What is the subject, and how will I compose the photograph?		
➔	Focus.....📖	64–74
How important is background lighting to the photograph?		
➔	Exposure: Metering.....📖	75
What is more important, shutter speed or aperture?		
➔	Exposure: Exposure Mode.....📖	76–83
Is the subject very bright, very dark, or high contrast?		
➔	Exposure: Exposure Compensation.....📖	86
➔	Exposure: Bracketing.....📖	87–93
Will I need a flash?		
➔	Flash Photography.....📖	94–104
➔	Optional Accessories: Optional Speedlights.....📖	186–189
How do I want to control the shutter?		
➔	Self-Timer Mode.....📖	105–106
➔	Using a Remote Control.....📖	107–110

Using Camera Menus

Basic Menu Operations

The next four sections involve settings that can be accessed via the camera menu. To view the menu, turn the camera on and press the **MENU** button.



Choosing a Menu

The camera has four main menus: the playback menu, the shooting menu, the Custom Settings menu, and the setup menu. When the menu button is pressed, the camera displays the last menu used. To select a different menu:

1

If menu item is highlighted, press **MENU** button.

(To view menu names, press multi-selector left when icon is highlighted.)

2

Select menu.

3

Position cursor in selected menu.

The Custom Settings Menu 161

The Custom Settings menu normally lists only options R through 9; if desired, all options can be displayed.

Making a Selection

To modify settings for an item in the current menu:

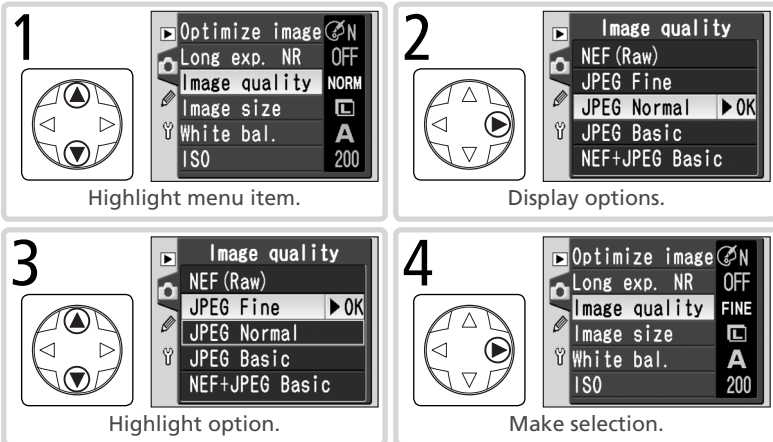

- To return to the previous menu without making a selection, press the multi-selector to the left.
- The selection for some options is made from a sub-menu. Repeat steps 3 and 4 to make a selection from a sub-menu.
- Some menu items may not be available in some modes, during recording, or when no memory card is inserted in the camera.
- Pressing the **ENTER** button performs the same function as pressing the multi-selector to the right. In some cases, a selection can only be made using **ENTER** button.

Exiting the Menus

To exit the menus, press the **MENU** button (if a menu option is highlighted, press the **MENU** button twice). You can also exit the menus by pressing the **▶** button to exit to playback mode or by turning the camera off. To exit the menus and focus the camera for the next shot, press the shutter-release button halfway.

Image Quality and Size

Making Effective Use of Memory

Together, image quality and size determine how much space each photograph occupies on the memory card.

Image Quality

The D70S supports the following image quality options (listed in descending order by image quality and file size):

Option	Format	Description	Compression ratio
NEF (Raw) (RAW)	NEF	Raw 12-bit data from CCD are saved directly to memory card in compressed Nikon Electronic Image Format (NEF) .	
JPEG Fine (FINE)	JPEG	Fine image quality, suitable for enlargements or high-quality prints.	Low (1:4)
JPEG Normal (NORM)		Normal image quality, suited to most applications.	Medium (1:8)
JPEG Basic (BASIC)		Basic image quality, suitable to distribution by e-mail or use in web pages.	High (1:16)
NEF+JPEG Basic (RAW BASIC)	NEF+JPEG	Two images are recorded, one NEF (RAW) image and one basic-quality JPEG image. Image size (📷 43) automatically set to L ; JPEG image is 3,008 x 2,000 pixels in size.	

📷 NEF (Raw)/NEF+JPEG

NEF images can only be viewed using Nikon Capture 4 version 4.2 or later (available separately; 📷 191) or PictureProject. When photographs taken at **NEF+JPEG Basic** are viewed on the camera, only the JPEG image will be displayed. When photographs taken at **NEF+JPEG Basic** are deleted, both NEF and JPEG images will be deleted.

📷 File Names

Photographs are stored as image files with names of the form "DSC_####.xxx," where *####* is a four-digit number between 0001 and 9999 assigned automatically in ascending order by the camera, and *xxx* is one of the following three letter extensions: "NEF" for NEF images, "JPG" for JPEG images, and "NDF" for Dust Off ref photos (📷 166). The NEF and JPEG files recorded at a setting of **NEF+JPEG Basic** have the same file names but different extensions. Images recorded at an **Optimize image > Color mode** setting of **II (Adobe RGB)** have names that begin with an underbar, e.g., "_DSC0001.JPG" (📷 56).

Image quality can be set using the **Image quality** option in the shooting menu or by pressing the **QUAL** button and rotating the main command dial.

The Image Quality Menu

1 Highlight **Image quality** in the shooting menu (📷 132) and press the multi selector to the right.



2 Highlight the desired option and press the multi selector to the right. The shooting menu will be displayed.

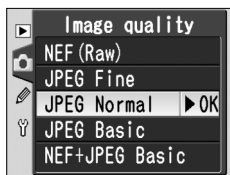

The QUAL Button

When the monitor is off, image quality can be set by pressing the **QUAL** button and rotating the main command dial. Image quality is displayed in the control panel:

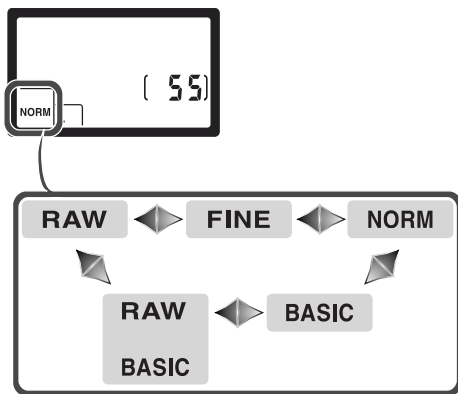
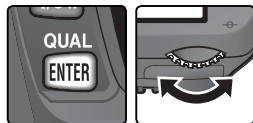





Image Size

Image size is measured in pixels. Smaller sizes produce smaller files, making them suited to distribution via e-mail or inclusion in web pages. Conversely, the larger the image, the larger the size at which it can be printed without becoming noticeably “grainy.” Choose image size according to the space available on the memory card and the task at hand.

Option	Size (pixels)	Size when printed at 200 dpi (approx.)
L (3008×2000)	3,008×2,000	38×25cm (15″×10″)
M (2240×1488)	2,240×1,488	28×19cm (11″×7.5″)
S (1504×1000)	1,504×1,000	19×13cm (7.5″×5″)

Image size can be set using the **Image size** option in the shooting menu or by pressing the **QUAL** button and rotating the sub-command dial. Image size can not be selected when **NEF (Raw)** or **NEF+JPEG Basic** is selected for image quality. When opened in Nikon Capture version 4.2 or later (available separately;  191) or PictureProject, NEF images are 3,008×2,000 pixels in size. When **NEF+JPEG Basic** is selected for image quality ( 41), the size of the JPEG image is fixed at **L** (3,008×2,000 pixels).

The Image Size Menu

- 1 Highlight **Image Size** in the shooting menu ( 132) and press the multi selector to the right.
- 2 Highlight the desired option and press the multi selector to the right. The shooting menu will be displayed.

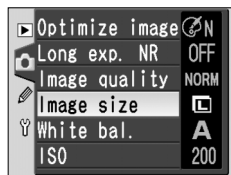

The QUAL Button

When the monitor is off, image size can be set by pressing the **QUAL** button and rotating the sub-command dial. Image size is displayed in the control panel:

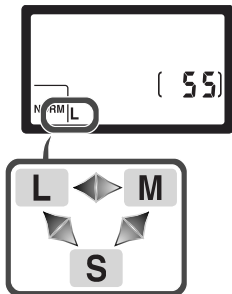

Memory Card Capacity and Image Quality/Size

The following table shows the approximate number of pictures that can be stored on a 256MB card at different image quality and size settings.

Image quality	Image size	File size*	No. of images*	Buffer capacity†
NEF (Raw)	—	5.0MB	44	4
JPEG Fine	L	2.9MB	73	9
	M	1.6MB	130	7
	S	0.8MB	279	19
JPEG Normal	L	1.5MB	144	12
	M	0.8MB	253	7
	S	0.4MB	528	27
JPEG Basic	L	0.8MB	279	19
	M	0.4MB	481	7
	S	0.2MB	950	49
NEF+JPEG Basic	L‡	5.8MB**	39	4

* All figures are approximate. File size varies with scene recorded and make of memory card.

† Maximum number of frames that can be stored in memory buffer. Actual number of photos that can be taken before buffer fills may vary with make of memory card.

‡ Size of JPEG image fixed at **L**. When opened in Nikon Capture 4 version 4.2 or later (available separately) or PictureProject, NEF image is 3,008×2,000 pixels.

**Total file size of NEF (RAW) and JPEG images.

Large-Capacity Memory Cards

When enough memory remains on the memory card to record a thousand or more pictures at current settings, the number of exposures remaining will be shown in thousands, rounded down to the nearest hundred (e.g., if there is room for approximately 1,260 exposures, the exposure count display will show 1.2K).

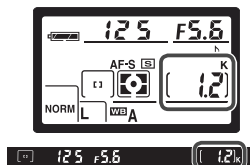

Sensitivity (ISO Equivalency)

Reacting Faster to Light

“Sensitivity” is the digital equivalent of film speed. The higher the sensitivity, the less light needed to make an exposure, allowing higher shutter speeds or smaller apertures.

Sensitivity can be set between values roughly equivalent to ISO 200 and ISO 1600 in steps equivalent to $\frac{1}{3}$ EV. Sensitivity can be adjusted using the **ISO** option in the shooting menu or by pressing the **ISO** button and rotating the main command dial.

The ISO Menu

1 Highlight **ISO** in the shooting menu (📷 132) and press the multi selector to the right.



2 Highlight the desired option and press the multi selector to the right. The shooting menu will be displayed.

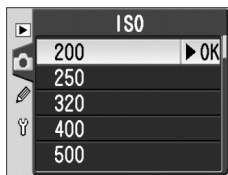

Sensitivity

The higher the sensitivity, the more likely pictures are to be subject to “noise” in the form of randomly-spaced, brightly-colored pixels.

5—ISO Auto (📷 142)

When **On** is selected for Custom Setting 5 (**ISO auto**), the camera will automatically vary sensitivity from the value selected by the user to help ensure optimum exposure.





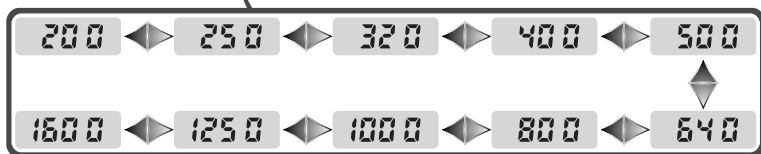
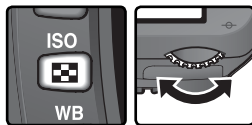

The ISO Button

When the monitor is off, sensitivity can be set by pressing the **ISO** button and rotating the main command dial. Sensitivity is displayed in the control panel:





The color of the light reflected from an object varies with the color of the light source. The human brain is able to adapt to changes in the color of the light source, with the result that white objects appear white whether seen in the shade, direct sunlight, or under incandescent lighting. Unlike the film used in film cameras, digital cameras can mimic this adjustment by processing images according to the color of the light source. This is known as “white balance.” For natural coloration, choose a white balance setting that matches the light source before shooting. When the mode dial is set to **P**, **S**, **A**, or **M**, white balance can be selected from the following options:

	Option	Approximate color temperature*	Description
A	Auto	3,500–8,000 K	White balance adjusted automatically based on color temperature from 1,005-pixel RGB sensor and CCD image sensor. For best results, use type G or D lens. With built-in Speedlight and optional SB-800 and 600 Speedlights, white balance reflects conditions in effect when Speedlight fires.
	Incandescent	3,000 K	Use under incandescent lighting.
	Fluorescent	4,200 K	Use under fluorescent lighting.
	Dir. sunlight	5,200 K	Use with subjects lit by direct sunlight.
	Flash	5,400 K	Use with Nikon Speedlights, including built-in Speedlight.
	Cloudy	6,000 K	Use in daylight under overcast skies.
	Shade	8,000 K	Use in daylight with subjects in the shade.
PRE	Preset	—	Use gray or white object or existing photograph as reference for white balance ( 52).

* Fine-tuning set to 0.

Auto white balance is recommended with most light sources. If the desired results can not be achieved with auto white balance, choose an option from the list above or use preset white balance.

White balance can be set using the **White bal.** option in the shooting menu or by pressing the **WB** button and rotating the main command dial.

The White Balance Menu

- 1 Highlight **White bal.** in the shooting menu (📷 132) and press the multi selector to the right.
- 2 Highlight the desired option and press the multi selector to the right. If **Preset** is selected, a menu of preset white balance options will be displayed (📷 52). Otherwise a white-balance fine-tuning dialog will be displayed (📷 50).



The WB Button

When the monitor is off, white balance can be set by pressing the **WB** button and rotating the main command dial. White balance is displayed in the control panel:

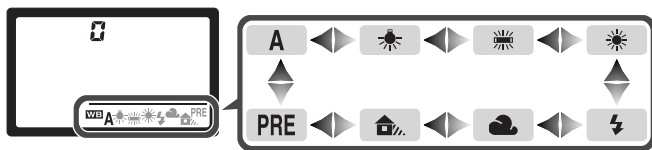
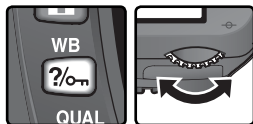

Speedlights Connected via a Sync Cable

Auto white balance may not produce the desired results when the AS-15 accessory shoe adapter is used to connect optional Speedlights via a sync cable. Use preset white balance or set white balance to **Flash** and use fine tuning to adjust white balance.

CSM 12—BKT Set (📷 146)

When **WB bracketing** is selected for Custom Setting 12 (**BKT set**), the camera will create several images each time the shutter is released. White balance will be varied with each image, “bracketing” the value currently selected for white balance.

Fine-Tuning White Balance

At settings other than **Preset**, white balance can be “fine tuned” to compensate for variations in the color of the light source or to introduce a deliberate “warm” or “cold” cast into an image. Higher settings can be used to lend images a bluish tinge or to compensate for light sources with a yellow or red cast, while lowering white balance can make photographs appear slightly more yellow or red or compensate for light sources with a blue cast. Adjustments can be made in the range +3 to –3 in increments of one. Except in **Fluorescent** mode, each increment is equivalent to about 10 mired.

White balance is fine tuned using the **White bal.** option in the shooting menu or by pressing the **WB** button and rotating the sub-command dial. At settings other than ± 0 , a ◀▶ icon appears in the control panel.

The White Balance Menu

- 1 In the white balance menu (📷 49), highlight an option other than **Preset** and press the multi selector to the right.
- 2 Press the multi selector up or down to choose the desired value and press the multi selector to the right. The shooting menu will be displayed.

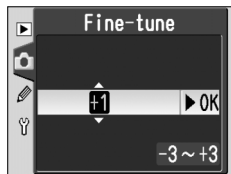
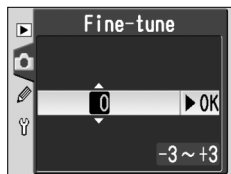

Color Temperature

The perceived color of a light source varies with the viewer and other conditions. Color temperature is an objective measure of the color of a light source, defined with reference to the temperature to which an object would have to be heated to radiate light in the same wavelengths. While light sources with a color temperature in the neighborhood of 5,000–5,500 K appear white, light sources with a lower color temperature, such as incandescent light bulbs, appear slightly yellow or red. Light sources with a higher color temperature appear tinged with blue.

The WB Button

When the monitor is off, white balance can be fine tuned by pressing the **WB** button and rotating the sub-command dial.

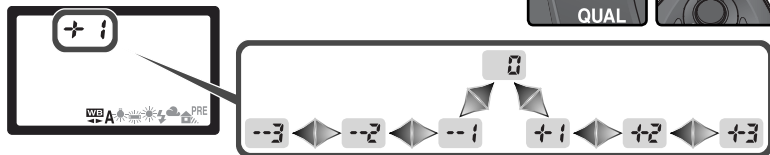
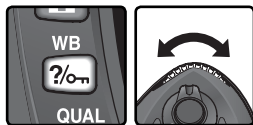

Fine-Tuning and Color Temperature

Approximate color-temperatures for settings other than **A** (auto) are given below (values may differ from color temperatures given by photo color meters):

	Incandescent	Fluorescent*	Direct sunlight	Flash	Cloudy (daylight)	Shade (daylight)
+3	2,700 K	2,700 K	4,800 K	4,800 K	5,400 K	6,700 K
+2	2,800 K	3,000 K	4,900 K	5,000 K	5,600 K	7,100 K
+1	2,900 K	3,700 K	5,000 K	5,200 K	5,800 K	7,500 K
±0	3,000 K	4,200 K	5,200 K	5,400 K	6,000 K	8,000 K
-1	3,100 K	5,000 K	5,300 K	5,600 K	6,200 K	8,400 K
-2	3,200 K	6,500 K	5,400 K	5,800 K	6,400 K	8,800 K
-3	3,300 K	7,200 K	5,600 K	6,000 K	6,600 K	9,200 K

* The size of the increments for **Fluorescent** reflects the wide variations in color temperature among the many different types of fluorescent light source, ranging from low-temperature stadium lighting to high-temperature mercury-vapor lamps.

"Mired"

Any given change in color temperature produces a greater difference in color at low color temperatures than it would at higher color temperatures. For example, a change of 1000 K produces a much greater change in color at 3000 K than at 6000 K. Mired, calculated by multiplying the inverse of the color temperature by 10^6 , is a measure of color temperature that takes such variation into account, and as such is the unit used in color-temperature compensation filters. E.g.:

- 4000 K – 3000 K (a difference of 1000 K) = 83 mired
- 7000 K – 6000 K (a difference of 1000 K) = 24 mired

Preset White Balance

Preset white balance is used to record and recall custom white balance settings for shooting under mixed lighting, to compensate for light sources with a strong color cast, or to replicate the white balance used in an existing photo. Two methods are available for setting preset white balance:

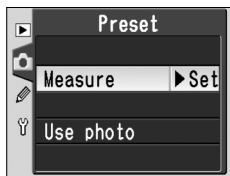

Method	Description
Measure white balance	Neutral gray or white object is placed under lighting that will be used in final photograph and white balance is measured by camera.
Copy from existing photograph	White balance value is copied from photo taken with D70S (if desired, source picture can be RAW image modified using white balance adjustment option in Nikon Capture 4 version 4.2 or later).

The camera can store only one value for preset white balance at a time; the existing value is overwritten when a new value is measured or copied. Measuring a new value for white balance automatically sets **Preset** to **Measure**.

Measuring a Value for White Balance

- Place a neutral gray or white object under the lighting that will be used in the final photograph. In studio settings, an 18% diffusion panel can be used to make the reference object appear gray.
- Select **Measure** in the **Preset** menu (55) or press the **WB** button and rotate the main command dial until **PRE** is displayed in the control panel. White balance will be set to the last value selected for preset white balance; if no previous value exists, white balance will be set to 5,200K, equivalent to **Dir. sunlight**.

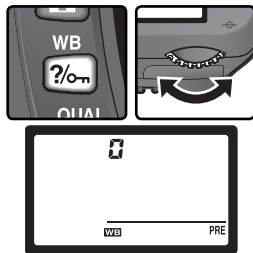

Measuring White Balance

Preset white balance can be measured in **P**, **S**, **A**, and **M** modes. In these modes, exposure is automatically increased by one EV to ensure accurate results. In mode **M**, optimal results can be obtained by setting exposure to ± 0 EV as indicated by the electronic analog exposure display.

- 3 Release the **WB** button briefly and then press the button until the **PRE** icon in the control panel starts to flash. A blinking **PrE** will also appear in the control panel and viewfinder frame-count displays.

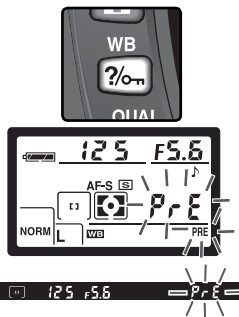

- 4 Frame the reference object so that it fills the viewfinder and press the shutter-release button all the way down. The camera will measure a value for white balance and use this value when preset white balance is selected. No photograph will be recorded; white balance can be measured accurately even when the camera is not in focus.

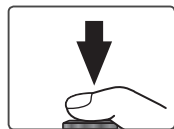

To exit without measuring a new value for white balance, press the **WB** button.

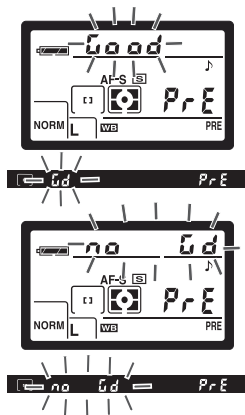

- 5 If the camera was able to measure a value for white balance, **Good** will flash in the control panel, while the viewfinder will show a flashing **Gd**. To return to shooting mode, press the shutter-release button halfway or wait until the exposure meters turn off.



If lighting is too dark or too bright, the camera may be unable to measure white balance. A flashing **no Gd** will appear in the control panel and viewfinder. Return to Step 4 and measure white balance again.

Copying White Balance from a Photograph

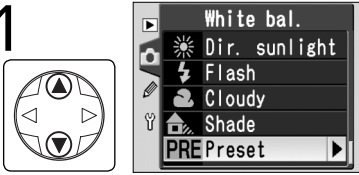
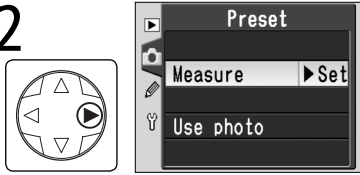
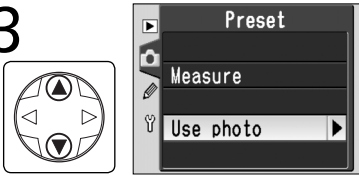
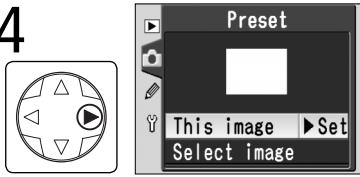
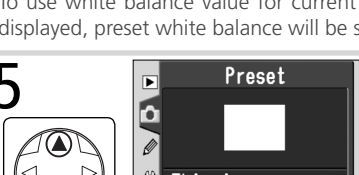
To copy a value for white balance from a photograph on the memory card, display the white balance menu (49) and follow the steps below:

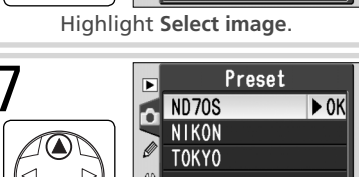
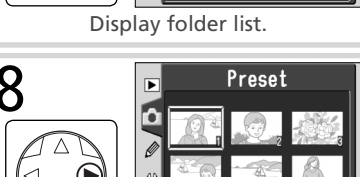
- 1**  Highlight **Preset**.
- 2**  Display options.
- 3**  Highlight **Use photo**.
- 4**  Display current source photo.*
- 5**  Highlight **Select image**.
- 6**  Display folder list.
- 7**  Highlight folder.
- 8**  Display images in selected folder.

* To use white balance value for current photo, proceed to Step 11. If no photo is displayed, preset white balance will be set to 5,200K (**Dir. sunlight**).

9

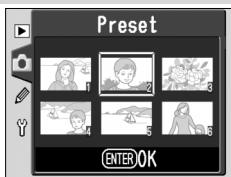
 Highlight photograph.[†]

10



Select photograph.

[†] Images displayed may include those created by other cameras, but only photographs created with D70S can be used as source for preset white balance.

11



Highlight This image.

12

 Set preset white balance to value for selected photograph.[‡]

[‡] To select different photo, repeat steps 5–12.

Using the Current Value for Preset White Balance

To set white balance to the value currently selected for preset white balance:

- 1 Highlight **Preset** in the white balance menu (49) and press the multi selector to the right.



- 2 Highlight **Measure** and press the multi selector to the right to set white balance to the current value for preset white balance and return to the shooting menu.





When a Digital Vari-Program mode is selected, the camera automatically optimizes outlines, contrast, saturation, and hue according to the type of scene. In **P**, **S**, **A**, and **M** modes, image enhancement options can be selected from **Normal**, **Vivid**, **Sharper**, **Softer**, **Direct Print**, **Portrait**, or **Landscape** to optimize photographs according to how the picture will be used or the type of scene. Sharpening, contrast, color reproduction, saturation, and hue can also be customized individually to match the user's creative intent.

Option	Description
Normal (default)	Recommended for most situations.
Vivid	Enhances saturation, contrast, and sharpness to produce vivid images with vibrant reds, greens, and blues.
Sharper	Sharpens outlines.
Softer	Softens outlines. Use to ensure smooth, natural-looking flesh tones in portrait subjects or when taking pictures that will be sharpened in image application.
Direct Print	Optimizes images for printing "as is" via direct USB connection (175). Images will be sharp and clear even when enlarged.
Portrait	Lowers contrast while lending natural texture and rounded feel to skin of portrait subjects.
Landscape	Enhances saturation and sharpness to produce landscapes with vibrant greens and blues.
Custom	Customize sharpness, contrast, color reproduction, saturation, and hue (57).

At Settings Other than Custom

At settings other than **Custom**:

- Photographs are optimized for current shooting conditions. Results will vary with exposure and the position of the subject in the frame, even in scenes of the same type. To take a series of photographs with identical image optimization, choose **Custom** and adjust settings individually, being sure not to select **Auto** for **Sharpening** or **Tone comp.**
- Photographs are recorded in the sRGB color space. When **Custom** is selected, the color space can be chosen in the **Color mode** menu (59).
- Use a type G or D lens for best results.

To select an image optimization option:

- 1 Highlight **Optimize image** in the shooting menu (132) and press the multi selector to the right.
- 2 Highlight the desired option and press the multi selector to the right. If **Custom** is selected, a menu of custom options will be displayed. In all other cases, the shooting menu will be displayed.

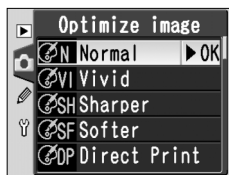
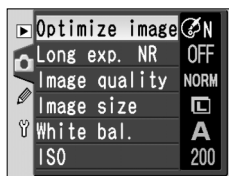

Customizing Image Enhancement Options

Select **Custom** to make separate adjustments to sharpening, contrast, color reproduction, saturation, and hue.







Making Edges More Distinct: Sharpening

During shooting, the camera processes photographs to emphasize the borders between light and dark areas, making pictures appear sharper. Sharpening can be customized using the **Sharpening** menu.

Option		Description
A	Auto (default)	Camera automatically adjusts sharpening according to subject. Results vary from shot to shot, even in scenes of same type; choose different setting to take multiple shots with same sharpening. For best results, use type G or D lens.
◇ 0	Normal	All images are sharpened by same standard amount.
◇ -2	Low	Images are sharpened less than standard amount.
◇ -1	Medium low	Images are sharpened slightly less than standard amount.
◇ +1	Medium high	Images are sharpened slightly more than standard amount.
◇ +2	High	Images are sharpened more than standard amount.
◇	None	Images are not sharpened.

Adjusting Contrast: Tone Comp.

As photographs are saved to the memory card, they are processed to adjust the distribution of tones in the image, enhancing contrast. Tone compensation is performed by means of tone curves that define the relationship between the distribution of tones in the original image and the compensated result. The **Tone comp.** menu controls the type of curve used.

Option		Description
A	Auto (default)	Camera automatically optimizes contrast by selecting appropriate curve. Curve varies from shot to shot, even in scenes of same type; to take multiple shots with same curve, choose different setting. For best results, use type G or D lens.
	0 Normal	Camera uses same standard curve for all images. Suited to most scenes, whether dark or bright.
	-2 Low contrast	Produces “softer” images. Prevents highlights on portrait subjects from being “washed out” in direct sunlight.
	-1 Medium low	Slightly less contrast than Normal .
	+1 Medium high	Slightly more contrast than Normal .
	+2 High contrast	Preserves detail in misty landscapes and other low-contrast subjects.
	Custom	Custom curve can be created in Nikon Capture 4 version 4.1 or later (available separately) and downloaded to camera. Choose Custom to select this user-defined curve. If no custom curve has been created, this option is equivalent to Normal .

Suiting Colors to a Workflow: Color Mode

The D70S offers a choice of color modes, which determine the gamut of colors available for color reproduction. Choose a color mode according to how photographs will be processed on leaving the camera.

Option	Description
Ia (sRGB) (default)	Choose for portrait shots that will be printed or used “as is,” with no further modification. Photographs are adapted to sRGB color space.
II (Adobe RGB)	Photographs taken at this setting are adapted to Adobe RGB color space. This color space is capable of expressing wider gamut of colors than sRGB, making it preferred choice for images that will be extensively processed or retouched.
IIIa (sRGB)	Choose for nature or landscape shots that will be printed or used “as is,” with no further modification. Photographs are adapted to sRGB color space.

Color Mode

Modes Ia and IIIa are recommended for photographs that will be printed without modification or viewed in applications that do not support color management, and for photographs that will be printed with ExifPrint, the direct printing option on some household printers, or kiosk printing or other commercial print services. Photos taken in Mode II can also be printed using these options, but colors will not be as vivid.



JPEG photographs taken in Mode II are Exif 2.21 and DCF 2.0 compliant; applications and printers that support Exif 2.21 and DCF 2.0 will select the correct color space automatically. If the application or device does not support Exif 2.21 and DCF 2.0, select the appropriate color space manually. For more information, see the documentation provided with the application or device.

Nikon Software

For best results when viewing photographs on a computer, use PictureProject (supplied) or Nikon Capture 4 version 4.2 or later (available separately). Nikon Capture, which makes an excellent addition to any imaging workflow, is unique in its ability to directly edit NEF files without affecting the image quality of the original, and belongs at the first stage of any production workflow involving image editing software. When photographs created with the D70S are opened in PictureProject or Nikon Capture 4 version 4.2 or later, the appropriate color space will be selected automatically.

Controlling Vividness: Saturation

Saturation controls the vividness of colors.

Option	Description
 Normal (default)	Normal vividness. Recommended for most situations.
 Moderate	Reduced vividness. Use when taking pictures that will later be retouched by computer.
 Enhanced	Increased vividness. Use for vivid, photoprint effect when taking pictures that will be printed “as is,” without further modification.

Controlling Color: Hue Adjustment



Hue can be adjusted in the range of about -9° to $+9^\circ$ in increments of 3° . If red is taken as the starting color, raising hue above 0° (the default setting) would introduce a yellow cast, making colors that would be red at a setting of 0° appear increasingly orange. Lowering hue below 0° would introduce a blue cast, making colors that would be red at a setting of 0° appear increasingly purple.

Hue

The RGB color model used in digital photographs reproduces colors using differing amounts of red, green, and blue light. By mixing two colors of light, a variety of different colors can be produced. For example, red combined with a small amount of green light produces orange. If red and green are mixed in equal amounts, yellow results, while a smaller amount of red produces a yellow green. Mixing different amounts of red and blue light produces colors ranging from a reddish purple through purple to navy, while mixing different amounts of green and blue light produces colors ranging from emerald to turquoise. (Adding a third color of light results in lighter hues; if all three are mixed in equal amounts, the results range from white through gray.) When this progression of hues is arranged in a circle, the result is known as a color wheel.



Choosing Custom Image Optimization Options

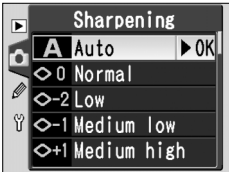

Choosing **Custom** in the **Optimize image** menu (🔧 57) displays the menu shown in Step 1.

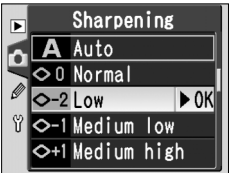

- 1**  

Highlight optimization option.
- 2**  

Display sub-menu.
- 3**  

Highlight option.
- 4**  

Make selection.
- 5** Repeat steps 1–4 to adjust other options.
- 6**  









Highlight **Done**.
- 7**  

Return to shooting menu.

Choosing a Shooting Mode

Single Frame, Continuous, Self-Timer, or Remote Control

Shooting mode determines how the camera takes photographs: one at a time, in a continuous sequence, with a timed shutter-release delay, or using a remote control.

Mode	Description
 Single frame	Camera takes one photograph each time shutter release button is pressed. Access lamp will light while photo is recorded; next shot can be taken immediately if enough space remains in memory buffer.
 Continuous	Camera records photographs at up to about three frames per second* while shutter-release button is held down.
 Self-timer	Use self-timer for self-portraits or to reduce blurring caused by camera shake ( 105).
 Delayed remote	Shutter release controlled using optional ML-L3 remote. Camera focuses when shutter-release button on ML-L3 is pressed; shutter is released after 2s delay ( 107). Gives operator time to pose when taking self-portrait using remote control.
 Quick-response remote	Shutter release controlled using optional ML-L3 remote. When shutter-release button on ML-L3 is pressed, camera releases shutter immediately after focusing ( 107). Ensures quick shutter response; can be used to reduce blurring caused by camera shake.

* Average frame rate in mode **M** with manual focus, shutter speed of $\frac{1}{250}$ s or faster, noise reduction off, and memory remaining in memory buffer. Number of pictures that can be stored in buffer depends on options selected for image quality and size (see table at right). Additional photographs can be taken as soon as enough memory is available in buffer.

Note that all pictures taken in continuous mode are recorded at the orientation for the first picture in each series, even if the camera orientation is changed during shooting. For example, if the first picture is taken with the camera in horizontal orientation, all pictures in the series will be recorded in “wide” (landscape) orientation, even if the camera is rotated to vertical orientation during shooting.

Quality	Size	Capacity
RAW	—	4
	L	9
FINE	M	7
	S	19
	L	12
NORM	M	7
	S	27
	L	19
BASIC	M	7
	S	49
	L	4

To choose a shooting mode, press the  button and rotate the main command dial. Shooting mode is displayed in the control panel:

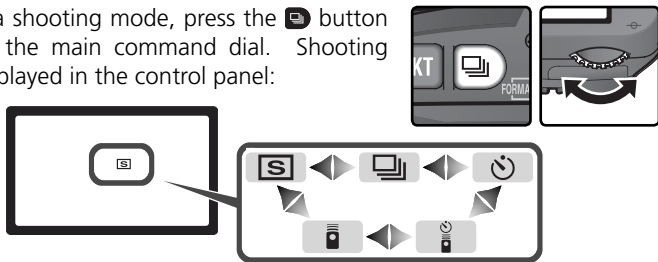

The Memory Buffer

The camera is equipped with a memory buffer for temporary storage, allowing shooting to continue while photographs are being saved to the memory card. When the buffer is full, the shutter is disabled until enough data have been transferred to the memory card to make room for another photograph. In continuous mode, shooting will continue as long as the shutter-release button is held down, although the frame rate will drop once the buffer has filled.

While photographs are being recorded to the memory card, the access lamp next to the memory card slot will light. Depending on the number of the images in the buffer, recording may take from a few seconds to a few minutes. **Do not remove the memory card or remove or disconnect the power source until the access lamp has gone out.** If the camera is switched off while data remain in the buffer, the power will not turn off until all images in the buffer have been recorded to the memory card. If the battery is exhausted while images remain in the buffer, the shutter release will be disabled and all images will be transferred to the memory card.

The approximate time required to write the entire buffer to a Lexar Media 40 × WA USB card is given below. Write times may drop when a microdrive card is used.

- NEF (RAW): 6 s (4 frames)
- JPEG Normal (size L): 9 s (12 frames)

Buffer Size

The number of images that can be stored in the memory buffer at current settings is shown in the exposure-count displays in the viewfinder and control panel while the shutter-release button is pressed. Note that the actual number of images that can be stored in the memory buffer may vary with the type of subject.

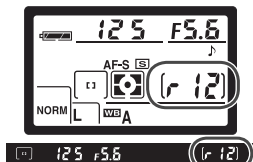





This section describes the options that control how your camera focuses: focus mode, focus-area selection, and AF-area mode.

Focus Mode

Focus mode is controlled by the focus mode selector on the front of the camera. Two modes are available:



Option	Description
<p style="text-align: center;">AF Autofocus</p>	<p>Camera focuses automatically when shutter-release button is pressed halfway. Operation depends on option selected for Custom Setting 2 (Autofocus;  139):</p> <ul style="list-style-type: none"> • AF-S (single-servo autofocus): When camera focuses, beep sounds and in-focus indicator (●) appears in viewfinder. Focus remains locked while shutter-release button is pressed halfway (<i>focus lock</i>). Shutter can only be released when in-focus indicator is displayed (<i>focus priority</i>). If subject was moving when shutter-release button was pressed halfway, camera will track subject until focusing is complete and the shutter can be released (<i>predictive focus tracking</i>;  65). If subject stops moving before shutter is released, in-focus indicator will appear in viewfinder and focus will lock at this distance. • AF-C (continuous-servo autofocus): Camera focuses continuously while shutter-release button is pressed halfway. If subject moves, focus will be adjusted to compensate (<i>predictive focus tracking</i>;  65). Photographs can be taken whether or not camera is in focus (<i>release priority</i>).
<p style="text-align: center;">M Manual</p>	<p>Camera does not focus automatically; focus must be adjusted manually using the lens focusing ring. If maximum aperture of lens is f/5.6 or faster, viewfinder focus indicator can be used to confirm focus (<i>electronic range finding</i>;  74), but photographs can be taken at any time, whether or not camera is in focus.</p>

Choosing single-servo AF ensures a sharp, focused image. Continuous-servo AF may be a better choice with erratically-moving subjects. Manual focus is recommended when the camera is unable to focus using autofocus.







Predictive Focus Tracking

If the camera autofocus system detects that the subject is moving when the shutter-release button is pressed halfway, it will automatically initiate predictive focus tracking. If the subject is moving toward or away from the camera, the camera will track focus while attempting to predict where the subject will be when the shutter is released. In single-servo autofocus, the camera will initiate predictive focus tracking if the subject was moving when the shutter-release button was pressed halfway. Focus will lock when the subject stops moving. In continuous-servo AF, the camera will also initiate predictive focus tracking if the subject starts moving after the shutter-release button is pressed halfway. Focus will not lock when the subject stops moving.

Predictive focus tracking is not available in manual focus mode.

Focus Area Selection

The D70S offers a choice of five focus areas that together cover a wide area of the frame. The focus area can be selected manually, allowing photographs to be composed with the main subject positioned almost anywhere in the frame, or automatically to ensure that the subject closest to the camera is always in focus regardless of where it is in the frame (closest-subject priority;  140).

Manual focus area selection is not available when closest-subject priority is selected in autofocus mode. Closest-subject priority is automatically selected when the mode dial is rotated to , , , , or ; to enable manual focus area selection in these modes, select **Single area** or **Dynamic area** for Custom Setting 3 (**AF-area mode**;  140).

Manual Focus Area Selection

To select the focus area, slide the focus selector lock to **L**. The multi selector can then be used to select the focus area. The selected focus area will be displayed in the viewfinder, highlighted in red if necessary to establish contrast with the background (“Vari-Brite” focus areas;  8). The selected focus area is also shown in the control panel.

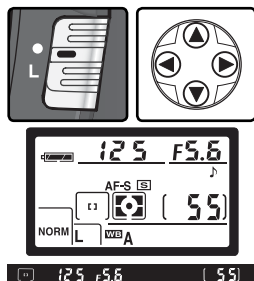

The focus selector lock can be set to **L** (lock) following selection to prevent the selected focus area from changing when the multi selector is pressed.

Focus Area Selection

The focus area can not be changed during playback or while menus are displayed.

CSM 3—AF-Area Mode (8) 140

Custom Setting 3 (**AF-area mode**) determines how the focus area is selected and what happens if the subject moves out of the selected focus area while the camera is still focusing. The current setting is indicated by the focus-area displays in the control panel and viewfinder.

Option	Display	Description
[1]		User selects focus area manually; camera focuses on subject in selected focus area only. Selected focus area is highlighted in viewfinder (8) when focus area is selected and when camera focuses. Use for relatively static compositions with subjects that will stay in selected focus area. Selected automatically when mode dial rotated to ; default setting for P , S , A , and M modes.
[+]		User selects focus area manually, but camera uses information from multiple focus areas to determine focus. Selected focus area is highlighted in viewfinder (8) when focus area is selected and when camera focuses. If subject leaves selected focus area even briefly, camera will still be able to focus based on information from other focus areas (focus-area selection does not change). Use when following erratically moving subjects and in other situations in which it is difficult to keep subject in selected focus area.
		Camera automatically selects focus area containing subject closest to camera. Focus area can not be selected manually, and focus area is not displayed in control panel; active focus area is highlighted in viewfinder when camera focuses. Prevents out-of-focus shots when photographing erratically moving subjects. Selected automatically when mode dial is rotated to , , , , , or













CSM 17—Focus Area (8) 148

This option can be used to set focus area selection to “wrap around.”

CSM 18—AF Area Illum (8) 149

Depending on the option selected for Custom Setting 18 (**AF area illum**), the active focus area will be highlighted briefly in red to improve contrast as needed (“Vari-Brite” focus areas), highlighted at all times, or never highlighted.

 Summary of Autofocus Options

Custom Setting 2 (Autofocus)	Custom Setting 3 (AF-area mode)	Control panel	View- finder	Active focus area	Focus-area selection
AF-S	Single area			Shown in viewfinder and control panel	Manual
	Dynamic area			Shown in viewfinder and control panel	Manual
	Closest subjct			Not shown	Automatic
AF-C	Single area			Shown in viewfinder and control panel	Manual
	Dynamic area			Shown in viewfinder and control panel	Manual
	Closest subjct			Not shown	Automatic



How it works	When to use it
Camera focuses on subject in selected focus area. Beep sounds when camera has focused. Focus will remain locked while shutter-release button is pressed halfway.	Use with static subjects when time is available to compose photo.
Camera focuses on subject in selected focus area. If subject moves before camera has focused, camera will focus based on information from other focus areas. Beep sounds when camera has focused. Focus will remain locked while shutter-release button is pressed halfway.	Use with relatively static subjects when time is available to compose photo.
As above, except that camera automatically selects focus area containing subject closest to camera. Beep sounds and active focus area is highlighted in viewfinder when camera has focused.	Use when sure that subject will be closest object to camera but unsure where it will appear in final composition.
Camera continues to focus on subject in selected focus area while shutter-release button is pressed halfway.	Use with moving subjects that can be continuously framed in single focus area.
Camera focuses on subject in selected focus area. While shutter-release button is pressed halfway, camera tracks subject as it moves from one focus area to the next.	Use with subjects that are moving unpredictably.
As above, except that camera automatically selects focus area containing subject closest to camera. Active focus area is highlighted in viewfinder when camera has focused.	Use with erratically moving subjects when you know subject will be closest object to camera.

Focus Lock

Focus lock can be used to change the composition after focusing, making it possible to focus on a subject that will not be in one of the five focus areas in the final composition. It can also be used when the autofocus system is unable to focus (👁️ 73).

When **AF-S** is selected for Custom Setting 2 (**Autofocus**; 👁️ 139), focus locks automatically when the in-focus indicator (●) appears in the viewfinder. When **AF-C** is selected, focus must be locked manually using the **AE-L/AF-L** button. To recompose a photograph using focus lock:

- 1 Position the subject in the selected focus area and press the shutter-release button halfway to initiate focus.

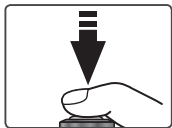
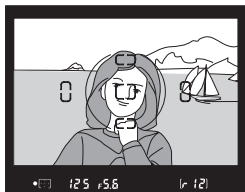

- 2 Check that the in-focus indicator (●) appears in the viewfinder.

AF-S (Single-servo AF)

Focus will lock automatically when the in-focus indicator appears, and remain locked until you remove your finger from the shutter-release button. Focus can also be locked by pressing the **AE-L/AF-L** button (see below).

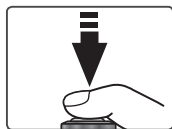

AF-C (Continuous-servo AF)

Press the **AE-L/AF-L** button to lock both focus and exposure. Focus will remain locked while the **AE-L/AF-L** button is pressed, even if you later remove your finger from the shutter-release button.

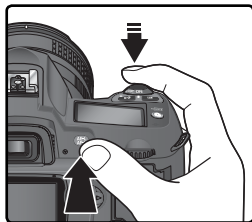

3 Recompose the photograph and shoot.

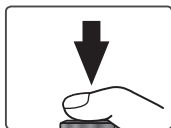

In single-servo AF (**AF-S**), focus will remain locked between shots as long as the shutter-release button is kept pressed halfway, allowing several photographs in succession to be taken at the same focus setting. Focus will also remain locked between shots while the **AE-L/AF-L** button is pressed.

Do not change the distance between the camera and the subject while focus lock is in effect. If the subject moves, focus again at the new distance.

AF-Area Mode

Select **Single area** or **Dynamic area** for Custom Setting 3 (**AF-area mode**;  140) when focusing using focus lock.

Mode

AF-C is selected automatically when the mode dial is rotated to .



15—AE-L/AF-L (147)

This option controls whether the **AE-L/AF-L** button locks focus and exposure (the default setting), focus only, or exposure only.

The AF-Assist Illuminator

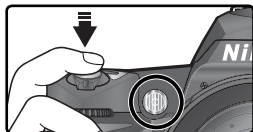
The built-in AF assist illuminator enables the camera to focus even when the subject is poorly lit. To use the illuminator, **AF-S** must be selected for Custom Setting 2 (**Autofocus**;  139), an AF-Nikkor lens must be attached, and the center focus area must be selected or closest subject priority in effect. If these



these conditions are met and the subject is poorly lit, the illuminator will light automatically to assist the autofocus operation when the shutter-release button is pressed halfway. The AF-assist illuminator is not available in  (Landscape),  (Sports), and  (Night landscape) modes.

For the AF-assist illuminator to function correctly, the lens must have a focal length of 24–200mm and the subject must be in range of the illuminator. Lens hoods should be removed. With most lenses, the illuminator has a range of about 0.5–3m (1'8"–9'10"). With the following lenses, autofocus with AF-assist illumination is not available at ranges under 1 m (3'3"):

- AF Micro ED 200mm f/4
- AF-S DX ED 12–24mm f/4
- AF-S ED 17–35mm f/2.8
- AF ED 18–35mm f/3.5–4.5
- AF-S DX 18–70mm f/3.5–4.5
- AF 20–35mm f/2.8
- AF ED 24–85mm f/2.8–4
- AF ED 24–85mm f/3.5–4.5
- AF-S VR ED 24–120mm f/3.5–5.6
- AF 24–120mm f/3.5–5.6
- AF ED 28–200mm f/3.5–5.6
- AF Micro ED 70–180mm f/4.5–5.6

With the following lenses, AF assist is not available at ranges under 2 m (6'7"):

- AF-S ED 28–70mm f/2.8
- AF-S DX ED 17–55mm f/2.8

AF assist is not available with the following lenses:

- AF-S VR ED 70–200mm f/2.8
- AF-S ED 80–200mm f/2.8
- AF ED 80–200mm f/2.8
- AF VR ED 80–400mm f/4.5–5.6
- AF-S VR ED 200–400mm f/4

If an optional SB-800 or SB-600 Speedlight is used, the camera AF-assist illuminator will turn off and the Speedlight illuminator will be used instead. With other Speedlights, the camera AF assist illuminator will be used.

4—AF Assist (141)

This option can be used to turn the AF-assist illuminator off.

Getting Good Results with Autofocus

Autofocus does not perform well under the conditions listed below. If the camera is unable to focus using autofocus, use manual focus (📷 74) or use focus lock (📷 70) to focus on another subject at the same distance and then recompose the photograph.

There is little or no contrast between the subject and the background

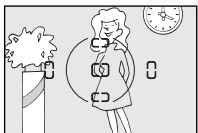

Example: subject is the same color as the background.

The focus area contains objects at different distances from the camera



Example: subject is inside a cage.

The subject is dominated by regular geometric patterns

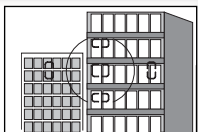

Example: a row of windows in a skyscraper.

The focus area contains areas of sharply contrasting brightness



Example: subject is half in the shade.

The subject appears smaller than the focus area



Example: focus area contains both foreground subject and distant buildings.

The subject many contains fine details

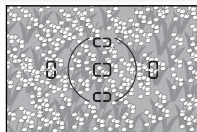

Example: a field of flowers or other subjects that are small or lack variation in brightness.

🔦 Continuous Use of the AF-Assist Illuminator (📷 72)

After the AF-assist illuminator has been used for several consecutive shots, it may turn off briefly to protect the lamp. The illuminator can be used again after a short pause. Note that the illuminator may become hot with continuous use.

Manual Focus

Manual focus is available for lenses that do not support autofocus (non-AF Nikkor lenses) or when autofocus does not produce the desired results (📷 73). To focus manually, set the focus-mode selector to **M** and adjust the lens focusing ring until the image displayed on the clear matte field in the viewfinder is in focus. Photographs can be taken at any time, even when the image is not in focus.

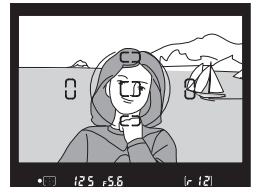
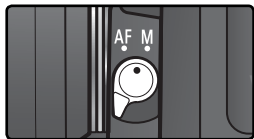

The Electronic Range Finder

If the lens has a maximum aperture of $f/5.6$ or faster, the viewfinder focus indicator can be used to confirm whether the subject in the selected focus area is in focus. After positioning the subject in the active focus area, press the shutter-release button halfway and rotate the lens focusing ring until the in-focus indicator (●) is displayed.

A-M Selection/Autofocus with Manual Priority

When using a lens that offers A-M selection, select M when focusing manually. With lenses that support M/A (autofocus with manual priority), focus can be adjusted manually with the lens set to M or M/A. See the documentation provided with your lens for details.

Focal Plane Position



To determine the distance between your subject and the camera, measure from the focal plane mark on the camera body. The distance between the lens mounting flange and the focal plane is 46.5 mm (1.83").





Metering

In **P**, **S**, **A**, and **M** modes, the metering mode determines how the camera sets exposure. The following options are available when a CPU lens is attached (metering is not performed when a non-CPU lens is used).

Method	Description
 3D color matrix/ Color matrix	Metering is performed by 1,005-pixel RGB sensor, which sets exposure based on variety of information from all areas of frame. This method is particularly effective where frame is dominated by bright (white or yellow) or dark (black or dark green) colors, when its results approach what is seen by human eyes. <i>3D color matrix metering</i> , which uses range information from lens in adjusting exposure, is available only with type G or D lenses. <i>Color matrix metering</i> , which does not include range information, is available with other CPU lenses. Matrix metering will not produce desired results with autoexposure lock (🔒 84) or exposure compensation (🔒 86), but is recommended in most other cases.
 Center-weighted	Camera meters entire frame but assigns greatest weight to area in center of frame 8mm (0.31") in diameter, shown by corresponding 8-mm reference circle in viewfinder. Classic meter for portraits; recommended when using filters with exposure factor (filter factor) over 1 × (🔒 191).
 Spot	Camera meters circle 2.3mm (0.09") in diameter (approximately 1% of frame). Circle is centered on current focus area, making it possible to meter off-center subjects (if Closest subject is selected for AF-area mode, camera will meter center focus area). Ensures that subject will be correctly exposed, even when background is much brighter or darker.

To choose a metering mode, press the  button and rotate the main command dial. Metering mode is displayed in the control panel:

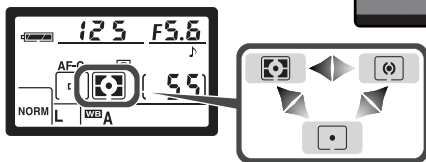
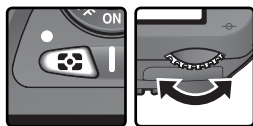

11—Center Wtd (🔒 145)

This option controls the size of the area assigned the greatest weight in center-weighted metering.

Exposure Mode

When the mode dial is rotated to **P**, **S**, **A**, or **M**, the user can set shutter speed and aperture as described on the following pages.

CPU Lenses

When using a CPU lens equipped with an aperture ring, lock the aperture ring at the minimum aperture (highest *f*-number). At other settings, the shutter release will be disabled and a blinking **FE E** will appear in the aperture displays in the top control panel and viewfinder. Type G lenses are not equipped with an aperture ring.

Non-CPU Lenses

Non-CPU lenses can only be used in mode **M**, when aperture can be adjusted manually using the lens aperture ring. In other modes, the shutter-release will be disabled and a blinking **F -** will appear in the control panel and viewfinder aperture displays.

Depth-of-Field Preview

To preview the effects of aperture, press and hold the depth-of-field preview button. If a CPU lens is attached, the lens will be stopped down to the aperture value selected by the camera (**P** and **S** modes) or the value chosen by the user (**A** and **M** modes), allowing depth of field to be previewed in the viewfinder (depth-of-field preview is not available with non-CPU lenses).

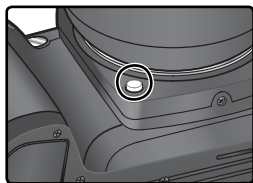

5—ISO Auto 142

When **On** is selected for Custom Setting 5 (**ISO auto**), the camera automatically varies sensitivity in the range 200–1600 (ISO equivalent) to help ensure optimum exposure and flash level. In **P** and **A** modes, the camera adjusts sensitivity when the shutter speed needed to obtain optimum exposure would be faster than $\frac{1}{8000}$ s or slower than a specified value (shutter speed may drop below the specified value if optimal exposure can not be achieved at ISO 1600 equivalent). Otherwise the camera adjusts sensitivity when the limits of the camera exposure metering system are exceeded (mode **S**) or when optimum exposure can not be achieved at the shutter-speed and aperture selected by the user (mode **M**).

When sensitivity is altered from the value selected by the user, **ISO AUTO** flashes in the control panel and viewfinder. In the camera photo information display for pictures taken at altered sensitivities, the ISO value will be displayed in red. Note that noise is more likely to appear in photographs taken at higher sensitivities.

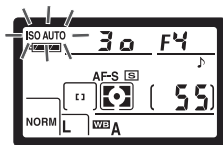

P: Auto Multi Program

In this mode, the camera automatically adjusts shutter speed and aperture according to a built-in program (📷 78) for optimal exposure in most situations. This mode is recommended for snapshots and other situations in which you want to leave the camera in charge of shutter speed and aperture. Adjustments can be made using flexible program, exposure compensation (📷 86), and auto exposure bracketing (📷 87). Mode **P** is only available with CPU lenses.

To take photographs in auto multi program:

1 Rotate the mode dial to **P**.



2 Frame a photograph, focus, and shoot.

📷 Flexible Program

In mode **P**, different combinations of shutter speed and aperture can be selected by rotating the main command dial (“flexible program”). All combinations produce the same exposure. While flexible program is in effect, a **P*** icon appears in the control panel. To restore the default shutter speed and aperture, rotate the main command dial until the **P** icon is no longer displayed. Defaults can also be restored by turning the camera off, rotating the mode dial, raising or lowering the built-in Speedlight, performing a two-button reset (📷 111), or choosing another setting for Custom Setting 9 (**EV step**; 📷 144).

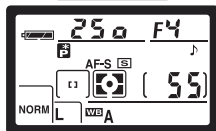

Exposure Warning

If the limits of the exposure metering system are exceeded, one of the following indicators will be displayed in the control panel and viewfinder:

Indicator	Description
HI	Subject too bright. Use optional Neutral Density (ND) filter or lower sensitivity (46).
L0	Subject too dark. Raise sensitivity (46).

If the flash-ready indicator (⚡) blinks in the viewfinder, the flash can be used for additional lighting. The flash-ready indicator will not be displayed if **Off** is selected for Custom Setting 20 (**Flash sign**).

Exposure Program

The exposure program for mode **P** is shown in the following graph:

AF 50 mm f/1.4D
 AF ED 180 mm f/2.8D
 AF-S ED 300 mm f/4D

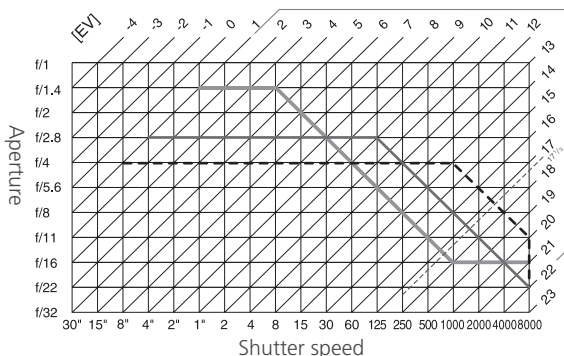

The maximum and minimum values for EV vary with sensitivity (ISO equivalency); the above graph assumes a sensitivity of ISO 200 equivalent. When matrix metering is used, values over 17 1/3 EV are reduced to 17 1/3 EV.

S: Shutter-Priority Auto

In mode **S**, you choose the shutter speed while the camera automatically selects the aperture that will produce the optimal exposure. Shutter speed can be set to values between 30s and $\frac{1}{8,000}$ s. Use slow shutter speeds to suggest motion by blurring moving objects, high shutter speeds to “freeze” motion. Mode **S** is only available with CPU lenses.

To take photographs in shutter-priority auto:

- 1 Rotate the mode dial to **S**.
- 2 Rotate the main command dial to choose the desired shutter speed.
- 3 Frame a photograph, focus, and shoot.

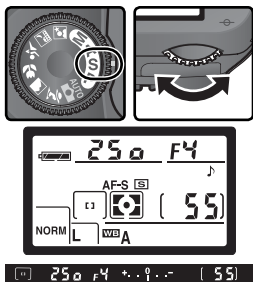

Exposure Warning

If the limits of the exposure metering system are exceeded, one of the following indicators will be displayed in the control panel and viewfinder:



Indicator	Description
H I	Subject too bright. Choose faster shutter speed or lower sensitivity (46), or use optional Neutral Density (ND) filter.
L O	Subject too dark. Choose slower shutter speed or higher sensitivity (46).

If the flash-ready indicator (4) blinks in the viewfinder, the flash can be used for additional lighting. The flash-ready indicator will not be displayed if **Off** is selected for Custom Setting 20 (**Flash sign**).

 **Changing from Mode M to Mode S**

If you select a shutter speed of **bulb** or **- -** (long time exposure) in mode **M** and then select mode **S** without changing the shutter speed, the shutter-speed display will flash and the shutter can not be released. Rotate the main command dial to select a different shutter speed before shooting.

 **Shutter Speed and Camera Shake**

To prevent blurring caused by camera shake, the shutter speed should be faster than the inverse of the focal length of the lens, in seconds (for example, if a lens has a focal length of 300mm, shutter speed should be faster than $\frac{1}{300}$ s). Use of a tripod is recommended when shooting at slower shutter speeds. To prevent blur, try increasing sensitivity ( 46), using the built-in Speedlight ( 94), or attaching a VR lens.

A: Aperture-Priority Auto

In mode **A**, you choose the aperture while the camera controls shutter speed for optimal exposure. Small apertures (high *f*-numbers) increase depth of field, bringing both the main subject and background into focus. Large apertures (low *f*-numbers) soften background details and let more light into the camera, increasing the range of the flash and making photographs less susceptible to blurring. Mode **A** is only available with CPU lenses.

To take photographs in aperture-priority auto:



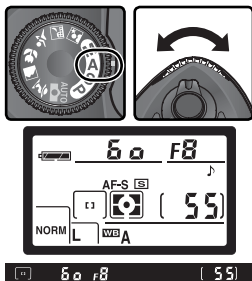

- 1 Rotate the mode dial to **A**.
- 2 Rotate the sub-command dial to choose the desired aperture.



- 3 Frame a photograph, focus, and shoot.

Exposure Warning

If the limits of the exposure metering system are exceeded, one of the following indicators will be displayed in the control panel and viewfinder:

Indicator	Description
	Subject too bright. Choose smaller aperture (larger <i>f</i> -number) or lower sensitivity ( 46), or use optional Neutral Density (ND) filter.
	Subject too dark. Choose larger aperture (smaller <i>f</i> -number) or higher sensitivity ( 46).

If the flash-ready indicator () blinks in the viewfinder, the flash can be used for additional lighting. The flash-ready indicator will not be displayed if **Off** is selected for Custom Setting 20 (**Flash sign**).

M: Manual

In mode **M**, the user controls both shutter speed and aperture. Shutter speed can be set to values between 30s and $\frac{1}{8,000}$ s, or the shutter can be held open indefinitely for a long time-exposure (**bULB**). Aperture can be set to values between the minimum and maximum values for the lens. Using the electronic analog exposure display in the viewfinder, you can adjust exposure according to shooting conditions and the task at hand.

To take photographs in manual exposure mode:

- 1 Rotate the mode dial to **M**.



- 2 Rotate the main command dial to choose a shutter speed, and the sub-command dial to set aperture. Check exposure in the electronic analog exposure display (see opposite), and continue to adjust shutter speed and aperture until the desired exposure is achieved.

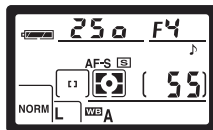
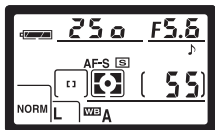

- 3 Frame a photograph, focus, and shoot.

 **The Flash-Ready Indicator**

If the flash-ready indicator (⚡) blinks in the viewfinder, the flash can be used for additional lighting. The flash-ready indicator will not be displayed if **Off** is selected for Custom Setting 20 (**Flash sign**).

 **Long Time-Exposures**

At a shutter speed of **bULb**, the shutter will remain open while the camera shutter-release button is held down. In delayed remote and quick-response remote modes, **-** is displayed instead of **bULb**; the shutter opens when the shutter-release button on the optional ML-L3 remote control is pressed (2 s after the button is pressed in delayed remote mode) and remains open until the remote-control shutter-release button is pressed a second time (maximum 30 minutes;  107). Nikon recommends using a fully-charged EN-EL3a battery or an optional EH-5 AC adapter to prevent loss of power while the shutter is open. Note that if the shutter is open for more than approximately 1 s at any setting, “noise” in the form of randomly-spaced, brightly-colored pixels may appear in the final photograph.

 **Non-CPU Lenses**

If a non-CPU lens is attached in mode **M**, **F-** will appear in the aperture displays in the control panel and viewfinder. Aperture must be adjusted manually using the lens aperture ring, and depth-of-field preview is not available. The camera exposure meter can not be used, and exposure will not be displayed in the electronic analog exposure display.

 **Electronic Analog Exposure Display**

The electronic analog exposure display in the viewfinder shows whether the photograph would be under- or over-exposed at current settings. Depending on the option chosen for Custom Setting 9 (**EV step**), the amount of under- or over-exposure is shown in increments of $\frac{1}{3}$ EV or $\frac{1}{2}$ EV. If the limits of the exposure metering system are exceeded, the display will flash.

“EV step” set to “1/3 step”	“EV step” set to “1/2 step”
Optimal exposure + . . 0 . . -	Optimal exposure + . . . 0 . . . -
Underexposed by $\frac{1}{3}$ EV + . . 0 . . -	Underexposed by $\frac{1}{2}$ EV + . . . 0 . . . -
Overexposed by more than 2 EV + . . . 0 . . -	Overexposed by more than 3 EV + 0 . . . -

Autoexposure Lock

When center-weighted metering is used, an area in the center of the frame is assigned the greatest weight when determining exposure. Similarly, when spot metering is used, exposure is based upon lighting conditions in the selected focus area. If the subject is not in the metered area when the picture is taken, exposure will be based on lighting conditions in the background, and the main subject may be under- or over-exposed. To prevent this, use autoexposure lock:

- 1 Rotate the mode dial to **P**, **S**, or **A** and select center-weighted or spot metering (exposure lock has no effect in mode **M**, while Digital Vari-Program modes are not recommended as center-weighted and spot metering can not be selected in these modes).

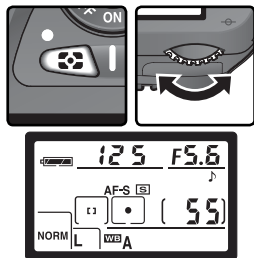

- 2 Position the subject in the selected focus area and press the shutter-release button halfway (when using center-weighted metering, position the subject in the center focus area). With the shutter-release button pressed halfway and the subject still positioned in the focus area, press the **AE-L/AF-L** button to lock exposure. Confirm that the in-focus indicator (●) appears in the viewfinder.

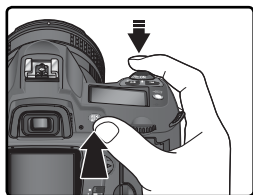
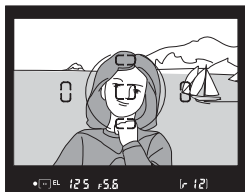

While exposure lock is in effect, an **EL** indicator will appear in the viewfinder.

3 Keeping the **AE-L/AF-L** button pressed, recompose the photograph and shoot.

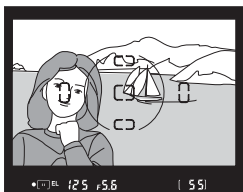

Metered Area

In spot metering, exposure will be locked at the value metered in a 2.3-mm (0.09") circle centered on the selected focus area. In center-weighted metering, exposure will be locked at the value metered in an 8-mm (0.31") circle at the center of the viewfinder.

Adjusting Shutter Speed and Aperture

While exposure lock is in effect, the following settings can be changed without altering the metered value for exposure:

Mode	Settings
P	Shutter speed and aperture (flexible program;  77)
S	Shutter speed
A	Aperture

The new values can be confirmed in the viewfinder and control panel. Note that the metering method can not be changed while exposure lock is in effect.

15—AE-L/AF-L (147)

Depending on the option selected, the **AE-L/AF-L** button locks both focus and exposure (the default setting), only focus, or only exposure. Options are available for keeping exposure locked until the **AE-L/AF-L** button is pressed a second time, the shutter is released, or exposure meters turn off.

16—AE Lock (148)





If **+Release bttn** is selected for **AE Lock**, exposure will lock when the shutter-release button is pressed halfway.

Exposure Compensation

To obtain the desired results with certain subject compositions, it may be necessary to use exposure compensation to alter exposure from the value suggested by the camera. As a rule of thumb, positive compensation may be needed when the main subject is darker than the background, negative values when the main subject is brighter than the background.

Exposure compensation is available in modes **P**, **S**, and **A** (in mode **M**, only the exposure information in the electronic analog exposure display is affected; shutter speed and aperture do not change).

- Pressing the  button, rotate the main command dial and confirm exposure compensation in the control panel or the electronic analog exposure display (the 0 in the electronic analog exposure display will flash). Exposure compensation can be set to values between -5EV (underexposure) and $+5\text{EV}$ (overexposure) in increments of $\frac{1}{3}\text{EV}$.

The current value for exposure compensation can be confirmed by pressing the  button. The current value is shown in the control panel with a  icon; in the viewfinder, positive values are shown by a  icon, negative values by a  icon.

- Frame the photograph, focus, and shoot.

Normal exposure can be restored by setting exposure compensation to ± 0 or performing a two button reset ( 111). Exposure compensation is not reset when the camera is turned off.

9—EV Step (144)

Use this option to set the increments for exposure compensation to $\frac{1}{2}\text{EV}$.

10—Exp Comp. (145)

If desired, exposure compensation can be set without pressing the  button.

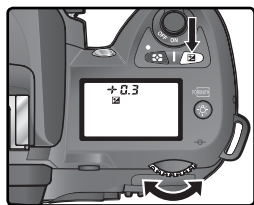

$\pm 0\text{EV}$ ( button pressed)

 $+0.3\text{EV}$

 -0.3EV

Bracketing





In **P**, **S**, **A**, and **M** modes, the D70S offers three types of bracketing (bracketing is not available in Digital Vari-Program modes). The type of bracketing performed is determined by the option selected for Custom Setting 12 (**BKT set**): **AE & flash**, **AE only**, **Flash only**, or **WB bracketing** (📷 146).

Type	Description
Exposure bracketing (AE & flash or AE only)	With each shot, camera varies exposure by maximum of $\pm 2\text{EV}$, “bracketing” exposure selected with exposure compensation (modes P , S , and A) or by user (mode M). One photograph is produced each time shutter is released; up to three shots are required to complete bracketing sequence.
Flash bracketing (AE & flash or Flash only)	Camera varies flash level by maximum of $\pm 2\text{EV}$ with each shot. One photograph is produced each time shutter is released; up to three shots are required to complete bracketing sequence. Available only in i-TTL and auto aperture flash control modes (📷 150).
White balance bracketing (WB bracketing)	Camera creates up to three images each time shutter is released, “bracketing” current white balance setting (📷 92). Only one shot is required to complete bracketing sequence. Recommended when shooting under mixed lighting or experimenting with different white balance settings. Not available at NEF (Raw) or NEF+JPEG Basic image quality.

Digital Vari-Program

If a Digital Vari-Program mode is selected while bracketing is in effect, bracketing will be suspended until **P**, **S**, **A**, or **M** mode is restored.

Exposure and Flash Bracketing

- 1 Select the type of bracketing to be performed using Custom Setting 12 (**BKT set**;  146). Choose **AE & flash** to vary both exposure and flash level (the default setting), **AE only** to vary only exposure, or **Flash only** to vary only flash level.
- 2 Pressing the  button, rotate the main command dial until **BKT** is displayed in the control panel and the  icons in the control panel and viewfinder start to blink.
- 3 Press the  button and rotate the sub-command dial to choose a bracketing program ( 90–91).

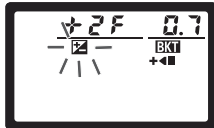
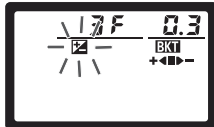
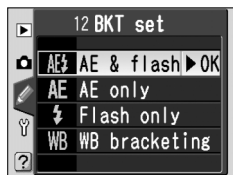

- 4 Compose a photograph, focus, and shoot. The camera will vary exposure and/or flash level shot-by-shot according to the bracketing program selected. Modifications to exposure and flash level are added to those made with exposure compensation (🔍 86) and flash exposure compensation (🔍 102).

While bracketing is in effect, the  icons in the control panel and viewfinder will flash. A segment will disappear from the bracketing progress indicator (➕◀■▶➖, ➕◀■, or ■▶➖) after each shot. The middle segment (■) disappears when the unmodified shot is taken, the ▶➖ segment when a shot with negative compensation is taken, and the ➕◀ segment when a shot with positive compensation is taken. Bracketing begins again when all shots in the sequence have been taken.

To cancel bracketing, press the  button and rotate the main command dial until **BKT** is no longer displayed in the control panel. The program last in effect will be restored the next time bracketing is activated. Bracketing can also be cancelled by selecting **WB bracketing** for Custom Setting 12 or by performing a two-button reset (🔍 111), although in this case the bracketing program will not be restored the next time bracketing is activated.

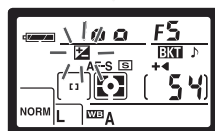
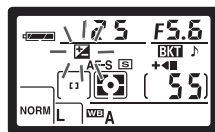
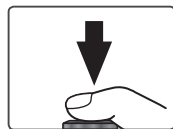

Shooting Mode

In single frame, self-timer, and remote control modes, one shot will be taken each time the shutter-release button is pressed. In continuous mode, shooting will pause after the number of shots specified in the bracketing program have been taken. Shooting will resume the next time the shutter-release button is pressed.

The bracketing programs available depend on the option selected for Custom Setting 9 (**EV step**;  144).

Custom Setting 9 (EV step)	Control panel display	No. of shots	Exposure increment	Bracketing order (EVs)
1/3 step (default)	3 F 0.3 +◀▶-	3	±1/3 EV	0, -0.3, +0.3
	3 F 0.7 +◀▶-	3	±2/3 EV	0, -0.7, +0.7
	3 F 1.0 +◀▶-	3	±1 EV	0, -1.0, +1.0
	3 F 1.3 +◀▶-	3	±1 1/3 EV	0, -1.3, +1.3
	3 F 1.7 +◀▶-	3	±1 2/3 EV	0, -1.7, +1.7
	3 F 2.0 +◀▶-	3	±2 EV	0, -2.0, +2.0
	+2 F 0.3 +◀	2	+1/3 EV	0, +0.3
	+2 F 0.7 +◀	2	+2/3 EV	0, +0.7
	+2 F 1.0 +◀	2	+1 EV	0, +1.0
	+2 F 1.3 +◀	2	+1 1/3 EV	0, +1.3
	+2 F 1.7 +◀	2	+1 2/3 EV	0, +1.7
	+2 F 2.0 +◀	2	+2 EV	0, +2.0
	--2 F 0.3 ▶-	2	-1/3 EV	0, -0.3
	--2 F 0.7 ▶-	2	-2/3 EV	0, -0.7
	--2 F 1.0 ▶-	2	-1 EV	0, -1.0
	--2 F 1.3 ▶-	2	-1 1/3 EV	0, -1.3
	--2 F 1.7 ▶-	2	-1 2/3 EV	0, -1.7
	--2 F 2.0 ▶-	2	-2 EV	0, -2.0

13—BKT Order (146)

This option can be used to change the bracketing order.

Custom Setting 9 (EV step)	Control panel display	No. of shots	Exposure increment	Bracketing order (EVs)
1/2 step	3 F 0.5 +<▶-	3	±½ EV	0, -0.5, +0.5
	3 F 1.0 +<▶-	3	±1 EV	0, -1.0, +1.0
	3 F 1.5 +<▶-	3	±1½ EV	0, -1.5, +1.5
	3 F 2.0 +<▶-	3	±2 EV	0, -2.0, +2.0
	+2 F 0.5 +<▶	2	+½ EV	0, +0.5
	+2 F 1.0 +<▶	2	+1 EV	0, +1.0
	+2 F 1.5 +<▶	2	+1½ EV	0, +1.5
	+2 F 2.0 +<▶	2	+2 EV	0, +2.0
	--2 F 0.5 ▶-	2	-½ EV	0, -0.5
	--2 F 1.0 ▶-	2	-1 EV	0, -1.0
	--2 F 1.5 ▶-	2	-1½ EV	0, -1.5
	--2 F 2.0 ▶-	2	-2 EV	0, -2.0

Resuming Exposure or Flash Bracketing

If the memory card fills before all shots in the sequence have been taken, shooting can be resumed from the next shot in the sequence after the memory card has been replaced or shots have been deleted to make room on the memory card. If the camera is turned off before all shots in the sequence have been taken, bracketing will resume from the next shot in the sequence when the camera is turned on.



Exposure and Flash Bracketing

The camera modifies exposure by varying shutter speed and aperture (mode **P**), aperture (mode **S**), or shutter speed (modes **A** and **M**). Changes to sensitivity required to attain optimum exposure or flash level when **On** is selected for Custom Setting 5 (**ISO auto**; 142) apply before exposure or flash bracketing is performed.



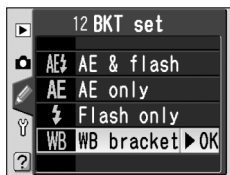

White Balance Bracketing

1 Choose **WB bracketing** for Custom Setting 12 (**BKT set**;  146). Note that white balance bracketing will not be performed if **NEF (Raw)** or **NEF+JPEG Basic** is selected for image quality.

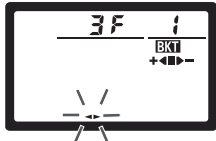

2 Pressing the **BKT** button, rotate the main command dial until **BKT** is displayed in the control panel. The  icon in the control panel and the arrows ( and ) at the ends of the electronic analog exposure display will start to blink.



3 Press the **BKT** button and rotate the sub-command dial to choose a bracketing program ( 93). Each increment is equivalent to about 10 mired ( 51); if the number of images in the bracketing program exceeds the number of exposures remaining, the bracketing progress indicator (, , or ) will blink.

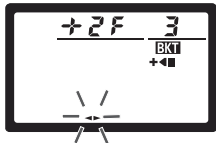
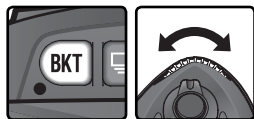

Shooting Mode

In all modes (including continuous mode), the shutter is released only once each time the shutter-release button is pressed. Each shot is processed to create the number of copies specified in the bracketing program.

Turning the Camera Off

If the power is turned off during recording, the camera will not power down until all shots in the bracketing sequence have been recorded.

4 Compose a photograph, focus, and shoot. Each shot will be processed to create the number of copies specified in the bracketing program, and each copy will have a different white balance. Modifications to white balance are added to the white balance adjustment made with white balance fine-tuning (📷 50).

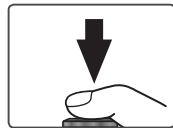

If the number of shots in the bracketing program exceeds the number of exposures remaining, **FULL** (**FuLL**) will be displayed and the bracketing progress indicator and number of exposures remaining will blink. Shooting can begin if a new memory card is inserted.

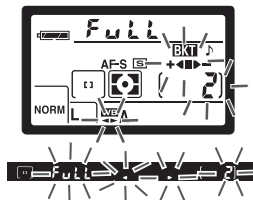

To cancel bracketing, press the **BKT** button and rotate the main command dial until **BKT** is no longer displayed in the control panel. The program last in effect will be restored the next time bracketing is activated. Bracketing can also be cancelled by selecting **NEF (Raw)** or **NEF+JPEG Basic** for image quality or performing a two-button reset (📷 111), although in this case reactivating bracketing will not restore the bracketing program.

The number of shots, white balance increment (WB), and bracketing order for each of the possible white-balance bracketing programs is shown below.

Control panel display	No. of shots	WB	Bracketing order
3F 1+◀▶	3	±1	0, -1, +1
3F 2+◀▶	3	±2	0, -2, +2
3F 3+◀▶	3	±3	0, -3, +3
+2F 1+◀	2	+1	0, +1
+2F 2+◀	2	+2	0, +2
+2F 3+◀	2	+3	0, +3

Control panel display	No. of shots	WB	Bracketing order
--2F 1 ▶	2	-1	0, -1
--2F 2 ▶	2	-2	0, -2
--2F 3 ▶	2	-3	0, -3

CSM 13—BKT Order (📷 146)



This option can be used to change the bracketing order.

The D70S is equipped with a Guide Number 15/49 Speedlight (ISO 200, m/ft; Guide Number at ISO 100 is 11/36). When a CPU lens is attached, the built-in Speedlight emits monitor preflashes that are analyzed using through-the-lens (TTL) technology (i-TTL flash control). The built-in Speedlight can be used not only when natural lighting is inadequate, but also to fill in shadows and backlit subjects or to add a catch light to the subject's eyes.

i-TTL Flash Control

The following types of flash control are available with CPU lenses:

Flash control	Description
i-TTL Balanced Fill-Flash for Digital SLR	i-TTL Balanced Fill-Flash for Digital SLR is selected automatically in all modes except mode M or when spot metering is selected in modes P , S , and A . Speedlight emits series of nearly invisible preflashes (monitor preflashes) immediately before main flash. Preflashes reflected from objects in all areas of frame are picked up by 1,005-pixel RGB sensor and are analyzed in combination with information from matrix metering system to adjust flash output for natural balance between main subject and ambient background lighting. If type G or D lens is used, distance information is included when calculating flash output.
Standard i-TTL Flash for Digital SLR	Standard i-TTL Flash for Digital SLR is activated automatically in mode M and when spot metering is selected in modes P , S , and A . Flash output adjusted to ensure main subject is correctly exposed; brightness of background is not taken into account. Recommended for shots in which main subject is emphasized at expense of background details, or when exposure compensation is used.







When a non-CPU lens is attached, the built-in Speedlight can only be used when **Manual** is selected for Custom Setting 19 (**Flash mode**;  150). If **TTL** selected, the shutter release will be disabled when the built-in Speedlight is raised. The flash-ready indicator () in the viewfinder and the  icon and borders of the flash sync mode indicator in the control panel will blink.

19—Flash Mode (150)

Flash mode can be selected from **TTL**, **Manual**, and **Commander mode**. In **Manual** mode, the built-in Speedlight has a Guide Number (m/ft) of 17/56 (ISO 200) or 12/39 (ISO 100). **Commander mode** can be used for wireless off-camera flash photography with SB-800 or SB-600 Speedlights.

Flash Sync Modes

The following flash sync settings are available in **P**, **S**, **A**, and **M** modes:



Flash sync mode	Description
 Front-curtain sync	This mode is recommended for most situations. In P and A modes, shutter speed will automatically be set to values between $\frac{1}{60}$ and $\frac{1}{500}$ s.
 Red-eye reduction	Red-eye reduction lamp lights for approximately 1 s before main flash, causing pupils in subject's eyes to contract and reducing "red-eye" effect sometimes caused by flash. Owing to 1 s shutter-release delay, red-eye reduction is not recommended with moving subjects or in other situations in which quick shutter response is required. Do not move camera while red-eye reduction lamp is lit.
 Slow sync	Flash is combined with shutter speeds as slow as 30 s to capture both subject and background at night or under dim light. Available only in P and A modes. Use of tripod is recommended to prevent blurring caused by camera shake.
 Slow sync with red-eye reduction	Combines red-eye reduction with slow sync. Available only in P and A modes. Use of tripod is recommended to prevent blurring caused by camera shake.
 Rear-curtain sync  Slow rear-curtain sync	In S and M modes, flash fires just before shutter closes, creating effect of stream of light following moving subjects. In P and A modes, slow-rear curtain sync is used to capture both subject and background. Use of tripod is recommended to prevent blurring caused by camera shake.









Flash Angle

The flash angle of the built-in Speedlight can cover the field of view of an 18 mm lens. It may not be able to light the entire subject with some lenses or apertures ( 101).





ISO Auto

When **On** is selected for Custom Setting 5 (**ISO auto**;  142), sensitivity will automatically be adjusted as required for optimal flash output. This may result in foreground subjects being underexposed in flash photographs taken at slow shutter speeds, in daylight, or against a bright background. In these cases, choose a flash mode other than slow sync or select mode **A** or **M** and choose a larger aperture.

The following flash sync settings are available in , , and  modes:

Flash sync mode	Description
 Auto front-curtain sync	If lighting is poor or subject is back-lit, flash pops up when shutter-release button is pressed halfway and fires automatically when shutter is released. Shutter speed is restricted to values between $\frac{1}{60}$ and $\frac{1}{500}$ s ($\frac{1}{125}$ and $\frac{1}{500}$ s in  mode). Auto front-curtain sync is selected automatically when mode dial is rotated to  ,  , or  .
 Auto with red-eye reduction	Combines red-eye reduction ( 95) with auto front-curtain sync.
 Off	Flash does not fire even when lighting is poor or built-in Speedlight is raised. Flash does not pop up automatically when shutter-release button is pressed halfway.

The following flash sync settings are available in  mode:

Flash sync mode	Description
 Auto slow sync	If lighting is poor or subject is back-lit, flash pops up when shutter-release button is pressed halfway. Flash is combined with shutter speeds as slow as 1 s to capture both subject and background at night or under dim light. Use of tripod is recommended to prevent blurring caused by camera shake. Auto slow sync is selected automatically when mode dial is rotated to  .
 Auto slow sync with red-eye reduction	Combines red-eye reduction ( 95) with auto slow sync. Use of tripod is recommended to prevent blurring caused by camera shake.
 Off	Flash does not fire even when lighting is poor or built-in Speedlight is raised. Flash does not pop up automatically when shutter-release button is pressed halfway.

Using the Built-in Speedlight

Follow these steps when using the built-in Speedlight with a CPU lens.

- 1 Rotate the mode dial to the desired setting (10). If **AUTO**, **2**, **3**, or **4** mode is selected, proceed to Step 4 (98). i-TTL Balanced Fill-Flash for Digital SLR will be selected, and the built-in Speedlight will pop-up automatically when required.



- 2 Choose a metering method. In **P**, **S**, and **A** modes, the metering method determines the type of flash control used (94); select matrix or center-weighted metering to activate i-TTL Balanced Fill-Flash for Digital SLR. Standard i-TTL Flash for Digital SLR is activated automatically in mode **M** and when spot metering is selected in modes **P**, **S**, and **A**.

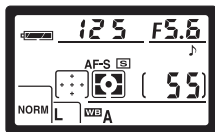

- 3 Press the **⚡** button. The built-in Speedlight will pop up and begin charging. When the Speedlight is fully charged, the flash-ready indicator will light.

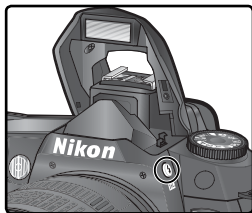

Auto Flash (**AUTO**, **2**, **3**, and **4** Modes)

The built-in Speedlight can not be raised and fired manually in **AUTO**, **2**, **3**, and **4** modes. Once raised, the built-in Speedlight will only fire when required for additional lighting.

Red-Eye Reduction

Some lenses may block the red-eye reduction lamp, preventing the subject from seeing the lamp and interfering with red-eye reduction.

When the Speedlight Is Not in Use

To save battery power when the Speedlight is not in use, return it to the closed position by pressing it lightly downward until the latch clicks into place.

- 4 Press the  button and rotate the main command dial until the desired flash sync icon is displayed in the control panel.

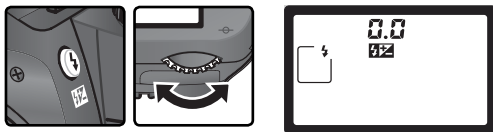



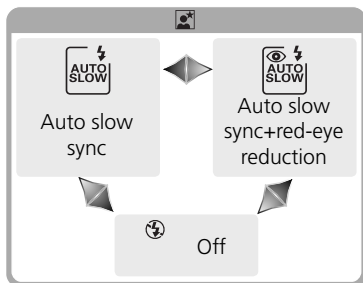
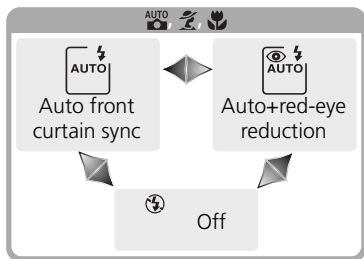
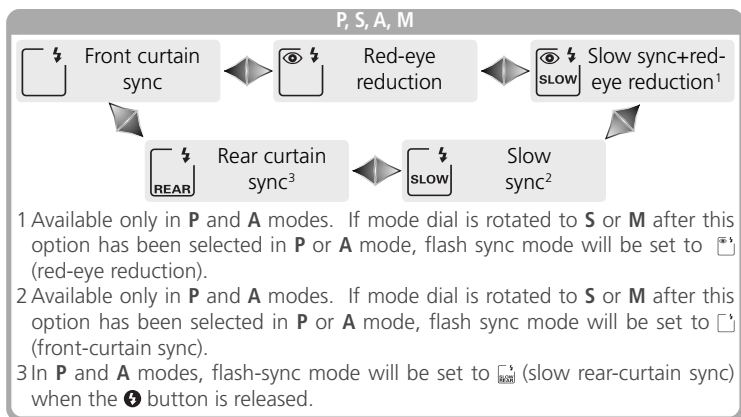





The options available depend on the mode selected with the mode dial:



Studio Flash Systems

Rear-curtain sync can not be used with studio flash systems, as the correct synchronization can not be obtained.

- 5 Press the shutter-release button halfway and check exposure (shutter speed and aperture). In , , , and  modes, the built-in Speedlight will pop up automatically if required for additional lighting and the flash will begin charging. The shutter speeds and apertures available when the built-in Speedlight is raised are listed below.

Mode	Shutter speed	Aperture	
P	Set automatically by camera ($1/500$ – $1/60$ s) ¹	Set automatically by camera	72
S	Value selected by user ($1/500$ –30 s) ²		79
A	Set automatically by camera ($1/500$ – $1/60$ s) ¹	Value selected by user ³	81
M	Value selected by user ($1/500$ –30 s) ²		82
 	Set automatically by camera ($1/500$ – $1/60$ s)	Set automatically by camera	—
	Set automatically by camera ($1/500$ – $1/125$ s)		—
	Set automatically by camera ($1/500$ –1 s)		—

1 Limit for slow shutter speed is set using Custom Setting 21 (**Shutter spd**;  152). Regardless of option selected, camera may set shutter to speeds as slow as 30 s at flash sync settings of slow sync, slow rear-curtain sync, and slow sync with red-eye reduction.

2 Speeds faster than $1/500$ s will be reduced to $1/500$ s when built-in Speedlight is raised or optional Speedlight is attached and turned on.

3 Flash range varies with aperture. Consult table of flash of flash ranges ( 100) when setting aperture in **A** and **M** modes.

- 6 Check that the flash-ready indicator appears  in the viewfinder. If the flash-ready indicator is not displayed when the built-in Speedlight is used, the shutter release will be disabled.

- 7 Compose the photograph, making sure that the subject is within range of the flash ( 100), then focus and shoot. If the flash-ready light blinks for about three seconds after the photograph is taken, the flash has fired at full output and the photograph may be underexposed. Check the results in the monitor. If the photograph is underexposed, adjust settings and try again.

Using the Built-in Speedlight

If the built-in Speedlight is used in continuous shooting mode, only one photograph will be taken each time the shutter-release button is pressed.

Vibration reduction (available with VR lenses) does not take effect if the shutter-release button is pressed halfway while the built-in Speedlight is recharging.



After the built-in Speedlight has been used for several consecutive shots, it may turn off briefly to protect the flash. The built-in Speedlight can be used again after a short pause.

Flash Range, Aperture, and Sensitivity

Flash range varies with sensitivity (ISO equivalency) and aperture.

Aperture at ISO equivalent of										Range	
200	250	320	400	500	640	800	1000	1250	1600	m	ft
2	2.2	2.5	2.8	3.2	3.5	4	4.5	5	5.6	1.0–7.5	3'3"–24'7"
2.8	3.2	3.5	4	4.5	5	5.6	6.3	7.1	8	0.7–5.4	2'4"–17'8"
4	4.5	5	5.6	6.3	7.1	8	9	10	11	0.6–3.8	2'–12'6"
5.6	6.3	7.1	8	9	10	11	13	14	16	0.6–2.7	2'–8'9"
8	9	10	11	13	14	16	18	20	22	0.6–1.9	2'–6'3"
11	13	14	16	18	20	22	25	29	32	0.6–1.4	2'–4'7"
16	18	20	22	25	29	32	—	—	—	0.6–0.9	2'–2'11"
22	25	29	32	—	—	—	—	—	—	0.6–0.7	2'–2'4"

The minimum distance at which the built-in Speedlight can be used is 0.6 m (2').

In **P**, **AUTO**, , , and  modes, the maximum aperture (minimum f/-number) is limited according to sensitivity (ISO equivalency) as shown below:

Mode	Maximum aperture at ISO equivalent of									
	200	250	320	400	500	640	800	1000	1250	1600
P , AUTO ,  , 	2.8	3	3.2	3.3	3.5	3.8	4	4.2	4.5	4.8
	5.6	6	6.3	6.7	7.1	7.6	8	8.5	9	9.5

For each one-step increase in sensitivity (e.g., from 200 to 400), aperture is stopped down by half an f-stop. If the maximum aperture of the lens is smaller than that listed above, the maximum value for aperture is the maximum aperture of the lens.

i-TTL flash control is available at all sensitivity (ISO equivalency) settings.

Compatible Lenses

The built-in Speedlight can be used with any CPU lens with a focal length of 18–300mm. Note that the built-in Speedlight may be unable to light the entire subject if the following lenses are not used at or above the minimum ranges given below:

Lens	Zoom position	Minimum range
AF-S DX ED 12–24mm f/4G	20mm	2.5m/8'2"
	24mm	1.0m/3'3"
AF-S ED 17–35mm f/2.8D	20mm, 24mm	2.5m/8'2"
	28mm	1.0m/3'3"
AF-S DX IF ED 17–55mm f/2.8G	20mm, 24mm	2.5m/8'2"
	28mm	1.5m/4'11"
	35mm	0.7m/2'4"
AF ED 18–35mm f/3.5–4.5D	20mm	2.0m/6'7"
	24mm	0.7m/2'4"
AF-S DX ED 18–70mm f/3.5–4.5G (IF)	18mm	1.0m/3'3"
AF 20–35mm f/2.8D	20mm	1.5m/4'11"
	24mm	1.0m/3'3"
AF-S VR ED 24–120mm f/3.5–5.6G	24mm	0.8m/2'7"
AF-S ED 28–70mm f/2.8D	28mm	3.0m/9'10"
	35mm	1.0m/3'3"
AF-S VR 200–400mm f/4G	200mm	4.0m/13'1"
	250mm	2.5m/8'2"

The minimum distance at which the built-in Speedlight can be used is 0.6m (2'). The built-in Speedlight can not be used in the macro range of macro zoom lenses.



The built-in Speedlight can also be used with Ai-S, Ai, and Ai-modified non-CPU lenses with a focal length of 18–200mm. Restrictions apply to the following lenses:

- Ai-S 25–50mm f/4, Ai 25–50mm f/4, and Ai-S 35–70mm f/3.5: can be used at 35mm at a range of 1.0m/3'3" or above
- Ai 50–300mm f/4.5, Ai-modified 50–300mm f/4.5, Ai-S ED 50–300mm f/4.5, and Ai-modified 85–250mm f/4: use at 135mm and above
- Ai ED 50–300mm f/4.5: use at 105mm and above
- Ai-S ED and Ai-ED 200mm f/2: can not be used

Flash Exposure Compensation

In **P**, **S**, **A**, and **M** modes, flash exposure compensation can be used to increase or reduce flash output from the level chosen by the camera's flash control system (flash exposure compensation is not available in Digital Vari-Program modes). Flash output can be increased to make the main subject appear brighter, or reduced to prevent unwanted highlights or reflections. As a rule of thumb, positive compensation may be needed when the main subject is darker than the background, negative compensation when the main subject is brighter than the background.

- 1 Rotate the mode dial to **P**, **S**, **A**, or **M** and choose a flash sync mode as described in Steps 1–4 of “Using the Built-in Speedlight” (📖 97–98).
- 2 Pressing the  button, rotate the sub-command dial and confirm flash exposure compensation in the control panel or viewfinder. Flash exposure compensation can be set to values between -3EV (darker) and $+1\text{EV}$ (brighter) in increments of $\frac{1}{3}\text{EV}$.

At values other than ± 0 , a  icon will be displayed in the control panel and viewfinder after you release the  button. The current value for flash exposure compensation can be confirmed by pressing the  button.

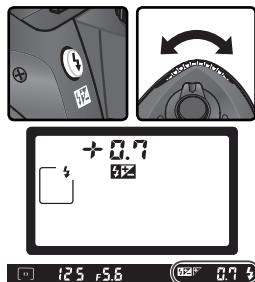

- 3 Take a picture as instructed in Steps 5–7 of “Using the Built-in Speedlight” (📖 99).

Normal flash output can be restored by setting flash exposure compensation to ± 0.0 or performing a two button reset (📖 111). Flash exposure compensation is not reset when the camera is turned off.

Using Flash Exposure Compensation with Optional Speedlights

Flash exposure compensation is also available with optional SB-800 and SB-600 Speedlights.

9—EV Step (📖 144)

This option can be used to set the increments for flash compensation to $\frac{1}{2}\text{EV}$.

FV Lock

This feature is used to lock flash output, allowing photographs to be re-composed without changing the flash level. This ensures that flash output is appropriate to the subject even when the subject is not positioned in the center of the frame. Flash output is adjusted automatically for any changes in sensitivity (ISO equivalency) or aperture. To use FV lock:

- 1 Select **FV Lock** for Custom Setting 15 (**AE-L/AF-L**;  147).



- 2 Rotate the mode dial to the desired setting and choose a flash sync mode as described in Steps 1–4 of “Using the Built-in Speedlight” ( 97–98).

- 3 Position the subject in the center of the frame and press the shutter-release button halfway to focus.

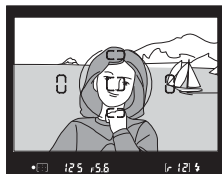
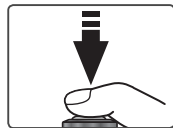

- 4 After confirming that the flash-ready indicator is displayed in the viewfinder, press the **AE-L/AF-L** button. The built-in Speedlight will emit a monitor preflash to determine the appropriate flash level. Flash output will be locked at this level and an **EL** icon will be displayed in the viewfinder.



5 Recompose the photograph.

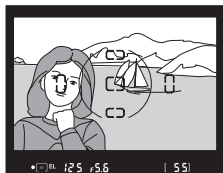

6 Press the shutter-release button the rest of the way down to shoot. If desired, additional pictures can be taken without releasing FV lock.



7 Press the **AE-L/AF-L** button to release FV lock and confirm that the **EL** icon is no longer displayed in the control panel and viewfinder.



Using FV Lock with the Built-in Speedlight

FV lock is only available with the built-in Speedlight when **TTL** (the default setting) is selected for Custom Setting 19 (**Flash mode**;  150).



Using FV Lock with Optional Speedlights

FV lock is also available with SB-800 and SB-600 Speedlights (available separately). Set the Speedlight to TTL mode (the SB-800 can also be used in AA mode; see the Speedlight manual for details). While FV lock is in effect, flash output will automatically be adjusted for changes in Speedlight zoom head position.



Self-Timer Mode

Delaying Shutter Release

The self-timer can be used to reduce camera shake or for self-portraits. To use the self-timer:

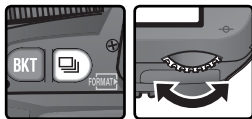
- 1 Mount the camera on a tripod (recommended) or place the camera on a stable, level surface.
- 2 Press the  button and rotate main command dial until  (self-timer mode) is displayed in the control panel.



- 3 Frame the photograph and focus. If autofocus is in effect, be sure not to block the lens when activating the self-timer. In single-servo autofocus ( 139), photographs can only be taken if the in-focus () indicator appears in the viewfinder.

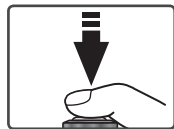

Cover the Viewfinder

To ensure correct exposure in modes other than **M**, cover the viewfinder eyepiece with your hand or with the supplied DK-5 eyepiece cap before pressing the shutter-release button. This will prevent light entering via the viewfinder from interfering with the autoexposure operation. The DK-5 can be attached by removing the viewfinder eyepiece cup and sliding the DK-5 down to cover the viewfinder eyepiece.

4 Press the shutter-release button all the way down to start the self-timer. The self-timer lamp (AF-assist lamp) will start to blink and a beep will begin to sound. Two seconds before the photograph is taken, the self-timer lamp will stop blinking and the beeping will become more rapid. After the photograph is taken, the shooting mode in effect before the self-timer was selected will be restored.



The Built-in Speedlight

In **P**, **S**, **A**, and **M** modes, the self-timer will be cancelled if the built-in Speedlight is raised before the picture is taken. To start the timer after raising the Speedlight, wait until the flash-ready indicator is displayed in the viewfinder and then press the shutter-release button.

The self-timer can be cancelled by selecting another shooting mode. Turning the camera off cancels the self-timer and restores the shooting mode in effect before self-timer mode was selected.

bulb

In self-timer mode, a shutter speed of **bulb** is equivalent to approximately 1/5s.

1—Beep **138**

This option controls the beep that sounds during the self-timer count-down.

24—Self-timer **153**

Self-timer delay can be set to 2s, 5s, 10s (the default setting), or 20s.



Using a Remote Control

Remote-Control Photography

The optional ML-L3 remote control can be used for self-portraits and to operate the camera remotely.

Before Using the Remote Control





Before using the remote control for the first time, remove the clear plastic battery insulator sheet.

Shooting mode	Description
 Delayed remote	Gives operator time to pose when taking self-portrait using remote control.
 Quick-response remote	Ensures quick shutter response; can be used to reduce blurring caused by camera shake.

Long Time-Exposures



When the remote control is used in mode M, **-** can be selected for shutter speed. At this setting, the shutter opens when the shutter-release button on the optional ML-L3 remote control is pressed (2 s after the button is pressed in delayed remote mode) and remains open until the remote-control shutter-release button is pressed a second time (maximum 30 minutes;  83). Nikon recommends using a fully-charged EN-EL3a battery or an optional EH-5 AC adapter to prevent loss of power while the shutter is open. Note that if the shutter is open for more than approximately 1 s at any setting, “noise” in the form of randomly-spaced, brightly-colored pixels may appear in the final photograph.

Using the Built-in Speedlight

In situations in which the flash is required, the camera will only respond to the shutter-release button on the ML-L3 once the flash has charged. In , , , and  modes, the flash will begin charging when delayed remote or quick-response remote mode is selected; once the flash has charged, the built-in Speedlight will pop up automatically if required when the shutter-release button on the ML-L3 is pressed. If red-eye reduction, slow sync with red-eye reduction, auto with red-eye reduction, or auto slow sync with red-eye reduction is selected, the self-timer lamp will light for about one second before the shutter is released. In delayed remote mode, the self-timer lamp will blink for two seconds and then light for one second before the shutter is released.

In **P**, **S**, **A**, and **M** modes, raising the built-in Speedlight during the two-second count-down in delayed remote mode will cancel the two-second timer. Wait for the flash to charge and press the shutter-release button on the ML-L3 to restart the timer.

To use the remote control:

- 1 Mount the camera on a tripod (recommended) or place the camera on a stable, level surface.
- 2 Press the  button and rotate main command dial until  (delayed remote) or  (quick response remote) is displayed in the control panel.

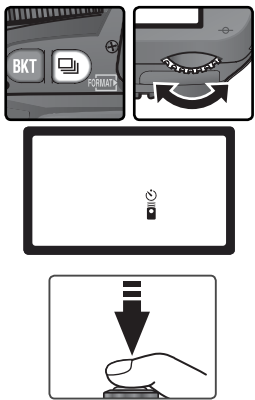
- 3 Frame the photograph. In autofocus (AF) mode, the camera shutter-release button can be used to check focus, although only the shutter release-button on the remote control can be used to release the shutter.

Cover the Viewfinder

To ensure correct exposure in modes other than **M**, cover the viewfinder eyepiece with your hand or with the supplied DK-5 eyepiece cap before pressing the shutter-release button. This will prevent light entering via the viewfinder from interfering with the autoexposure operation. The DK-5 can be attached by removing the viewfinder eyepiece cup and sliding the DK-5 down to cover the viewfinder eyepiece.

1—Beep **138**



This option controls the beep that sounds during the two-second count-down in delayed remote mode or when the shutter is released in quick-response remote mode.

25—Remote **154**

The length of time before the camera automatically cancels delayed remote or quick-response remote mode can be chosen from one, five, ten, or fifteen minutes.

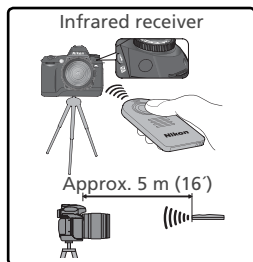
- 4 Aim the transmitter on the ML-L3 at the infrared receiver on the camera and press the shutter-release button on the ML-L3 (when using the remote outdoors, make sure that the subject is not backlit and that the line of site between the transmitter and the infrared receiver is not blocked by the lens or other obstacles). How the camera focuses and shoots depends on the option selected for Custom Setting 2 (**Autofocus**;  139).





Shooting mode	Custom Setting 2	
	AF-S (Single-servo AF)	AF-C (Continuous-servo AF)
 Delayed remote	Once camera has focused, self-timer lamp will light for 2 s before shutter is released. If unable to focus, camera will return to standby without releasing shutter.	Self-timer lamp lights for 2 s before shutter is released. Camera does not focus.
 Quick-response remote	Shutter is released immediately after camera focuses. Self-timer lamp will flash when shooting is complete. If unable to focus, camera will return to standby without releasing shutter.	Camera releases shutter immediately without focusing. Self-timer lamp will flash when shooting is complete.

The camera will not adjust focus in manual focus mode or if autofocus has been set using the shutter-release button on the camera.

Remote control mode can be cancelled by selecting another shooting mode. The shooting mode in effect before remote control mode was selected will also be restored if the camera is turned off or no operations are performed for the time selected for Custom Setting 25 (**Remote**;  154). The default setting is one minute.

The MC-DC1 Remote Cord (191)

The optional MC-DC1 remote cord can be used to operate the shutter remotely and prevent blur caused by camera shake. A shutter-release button lock is available for long time-exposures ( 83) and continuous shooting ( 62).

Replacing the Battery

The ML-L3 remote control is powered by a three-volt CR2025 lithium battery. To replace the battery:

- 1 After sliding the latch in the direction shown in ① to unlatch the battery holder, remove the holder as shown in ②.

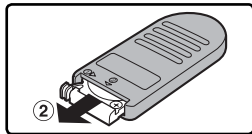
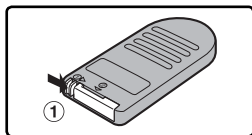

- 2 Remove the battery from the battery holder.

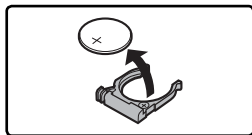

- 3 Insert a fresh battery with the face marked "+" on top.

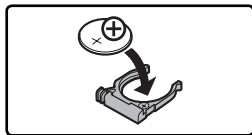

- 4 Slide the battery holder into the remote until the latch clicks into place.

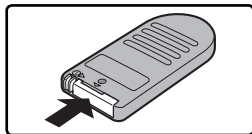

✓ Keep out of Reach of Children

Care should be taken to prevent infants from putting the battery or other small parts in their mouths. Should a child swallow the battery, consult a physician immediately.



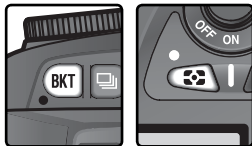

Two-Button Reset

Restoring Default Settings

The camera settings listed below can be restored to default values by holding the **BKT** and  buttons down together for more than two seconds (these buttons are marked by a green dot). Custom Settings are not affected.



Option	Default
Shooting mode	Single frame*
Focus area	Center†
Metering	Matrix
Flexible program	Off
AE hold	Off‡
Exposure compensation	±0
Bracketing	Off

Option	Default
Flash sync mode	
P, S, A, M	Front-curtain sync
  	Auto front-curtain sync
	Auto slow sync
Flash compensation	Off
FV lock	Off‡
LCD illuminator	Off

* Shooting mode is not reset in self-timer and remote modes.

† Not reset when **Closest subject** is selected for Custom Setting 3 (**AF-area mode**).

‡ Custom Setting 15 (**AE-L/AF-L**) is unaffected.

The following shooting-menu options will also be reset.

Option	Default
Image quality	JPEG Normal
Image size	L
White bal.	Auto*

Option	Default
ISO	200
Optimize image	Normal

* Fine tuning reset to 0.

R—Menu Reset 136

Custom Settings can be reset to default values by selecting **Reset** for Custom Setting R (**Menu reset**).

More About Playback

Playback Options

This section details the operations that can be performed during playback, including thumbnail playback, playback zoom, and photo information display.

Single-Image Playback

Photographs are displayed in the monitor during recording and when the  button is pressed.

During Recording



Photographs are automatically displayed while being recorded to memory card.

The Button



Press  button at any time to display most recent photograph.

Photographs taken in “tall” (portrait) orientation are displayed in tall orientation.



Using the Multi Selector

The multi selector can be used at any time when the monitor is on. The focus selector lock switch only takes effect when the monitor is off.

Rotate Tall 126

“Tall” (portrait-orientation) images are not displayed in tall orientation when **No** is selected for the **Rotate tall** option in the playback menu. Note that all photographs taken with **Off** selected for **Image rotation**  168 are displayed in “wide” (landscape) orientation, regardless of the option selected for **Rotate tall**.

7—Image Review 144

Photographs will not be displayed in the monitor during recording if **Off** is selected for Custom Setting 7 (**Image review**).

22—Monitor Off 153

The monitor will turn off automatically to save power if no operations are performed for the time specified in Custom Setting 22 (**Monitor off**).

The following operations can be performed in single-image playback:



















To	Press	Description
View additional photographs		Press multi selector down to view photographs in order recorded, up to view photographs in reverse order.
View photo information		Press multi selector left or right to view information about current photograph (116).
View thumbnails		Press  button to view thumbnail display (118).
Zoom in on photograph	 	Press  button for enlarged view of current photograph (120).
Protect/remove protection from photograph		Images marked by  icon can not be deleted using  button or Delete option in playback menu (note that protected images <i>will</i> be deleted when memory card is formatted). To protect image, or to remove protection from protected image, press  button (121).
Delete photograph		Press  button to delete current photograph (122). Confirmation dialog will be displayed; press  again to delete photo, or press any other button to exit without deleting photo. 
Display menus		Press  to end playback and display camera menus (39).
End playback	Shutter release/ 	To end playback and return to shooting mode, press  button or press shutter-release button halfway.

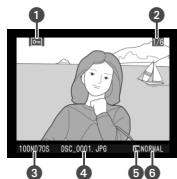

Photo Information

Photo information is superimposed on images displayed in single-image playback. Press the multi-selector left or right to cycle through photo information as follows: Shooting Data Page 2 ↔ Shooting Data Page 1 ↔ File Information ↔ Histogram ↔ Highlights.

File Information

- | | |
|---|-------------------------|
| 1 Protect status..... 121 | 4 File name..... 41 |
| 2 Frame number/total
number of images .126 | 5 Image size 43 |
| 3 Folder name 156 | 6 Image quality..... 41 |



Shooting Data, Page 1

- | | |
|---|-----------------------------------|
| 1 Protect status..... 121 | 7 Shutter speed 76 |
| 2 Frame number/total
number of images .126 | 8 Aperture 76 |
| 3 Camera name | 9 Exposure mode 76 |
| 4 Date of recording..... 16 | Exposure
compensation 86 |
| 5 Time of recording 16 | 10 Focal length..... 185 |
| 6 Metering 75 | 11 Flash control 94 |

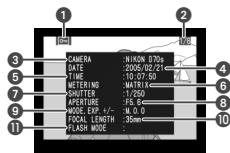

Shooting Data, Page 2

- | | |
|---|--------------------------|
| 1 Protect status..... 121 | 6 Image size 43 |
| 2 Frame number/total
number of images .126 | Image quality..... 41 |
| 3 Image optimization ..56 | 7 Sharpening 57 |
| 4 Sensitivity | 8 Tone compensation.. 58 |
| (ISO equivalency) 46 | 9 Color mode 59 |
| 5 White balance 48 | Hue 60 |
| White balance
adjustment 50 | 10 Saturation..... 60 |

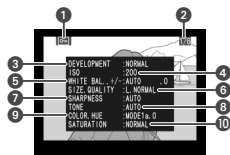
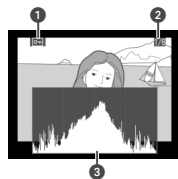

Image Comments

Image comments (🗨️ 163–164) do not appear in the photo information display.

Histogram

- 1 Protect status..... 121
- 2 Frame number/total number of images..... 126
- 3 Histogram showing the distribution of tones in the image. The horizontal axis corresponds to pixel brightness, with dark tones to the left and bright tones to the right. The vertical axis shows the number of pixels of each brightness in the image.



Highlights

- 1 Protect status..... 121
- 2 Image highlights (brightest areas of image) are marked by a flashing border.
- 3 Frame number/total number of images..... 126

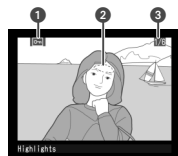









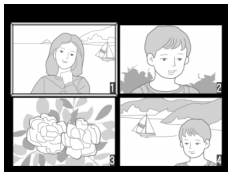













Histograms

Camera histograms are for use only as a guide and may differ from those displayed in imaging applications.

Viewing Multiple Images: Thumbnail Playback

To display images in “contact sheets” of four or nine images, press the  button in single-image playback. The following operations can be performed while thumbnails are displayed:



To	Press	Description
Change number of images displayed		Press  button to switch between four-thumbnail display, nine-thumbnail display, and single-image playback.
Highlight photographs		Press multi selector up, right, left, or down to highlight thumbnails.
Zoom in on photograph	 	Press  button for enlarged view of highlighted photograph ( 120).
Protect/remove protection from photograph		Images marked by  icon can not be deleted using  button or Delete option in playback menu (note that protected images <i>will</i> be deleted when memory card is formatted). To protect image, or to remove protection from protected image, press  button ( 121).
Delete photograph		Press  button to delete highlighted photograph ( 122). Confirmation dialog will be displayed; press  again to delete photo, or press any other button to exit without deleting photo.
Display menus		Press  to end playback and display camera menus ( 39).
End playback	Shutter release/ 	To end playback and return to shooting mode, press  button or press shutter-release button halfway.



Using the Multi Selector

The multi selector can be used at any time when the monitor is on. The focus selector lock switch only takes effect when the monitor is off.









22—Monitor Off 153

The monitor will turn off automatically to save power if no operations are performed for the time specified in Custom Setting 22 (**Monitor off**).





Taking a Closer Look: Playback Zoom



Press the **ENTER** button to zoom in on the image displayed in single-image playback or on the image currently highlighted in thumbnail playback. The following operations can be performed while zoom is in effect:

To	Press and/or rotate	Description
Cancel/ resume zoom	 (Q)	Press ENTER to cancel zoom and return to single-image or thumbnail playback. Press again to zoom image in.
Change zoom ratio/ navigate to other areas of image		Press  button. Navigation window in bottom right corner of monitor shows area that will be displayed when  button is released. Keeping  button pressed, rotate main command dial to change size of area selected or use multi-selector to move frame in navigation window to another location. Selected area will be displayed in monitor when  button is released. 
View other areas of image		Use multi selector to view area not visible in monitor. Hold multi selector down to scroll rapidly to other areas of frame. 

Protecting Photographs from Deletion

In full-frame and thumbnail playback, the  button can be used to protect photographs from accidental deletion. Protected files can not be deleted using the  button or the **Delete** option in the playback menu, and have DOS “read-only” status when viewed on a Windows computer. Note that protected images *will* be deleted when the memory card is formatted.

To protect a photograph:

- 1 Display the image in full-frame playback or highlight it in the thumbnail list.
- 2 Press the  button. The photograph will be marked with a  icon.

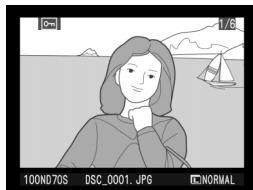
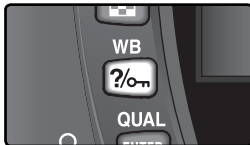



To remove protection from the photograph so that it can be deleted, display the photograph in full-frame playback or highlight it in the thumbnail list and then press the  button.

Deleting Individual Photographs

To delete a photograph displayed in single-image playback, or the photograph highlighted in thumbnail playback, press the  button. Once deleted, photographs can not be recovered.

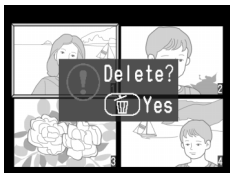
- 1 Display the image in full-frame playback or highlight it in the thumbnail list.
- 2 Press the  button. A confirmation dialog will be displayed.



- 3 To delete the photograph, press the  button again. Press any other button to exit without deleting the photograph.

Protected and Hidden Images

Images marked with a  icon are protected and can not be deleted. Hidden images are not displayed in single-image or thumbnail playback and can not be selected for deletion.

Delete 124

To delete multiple images, use the **Delete** option in the playback menu.

Menu Guide

Index to Menu Options

The Playback Menu

 124–131



The Shooting Menu

 132–134



Custom Settings

 135–154



The Setup Menu

 155–168



Changes to a variety of camera settings are made with the help of menus that appear in the camera monitor. This chapter covers:

The Playback Menu

The playback menu contains options for managing the images stored on memory cards, and for playing pictures back in automated slide shows.

The Shooting Menu

The shooting menu contains advanced shooting options, such as image optimization and noise reduction.

Custom Settings

The CSM (Custom Settings) menu controls fine details of camera operation.

The Setup Menu

This menu is used for basic camera setup, including formatting memory cards and setting the time and date.

The playback menu contains the following options:

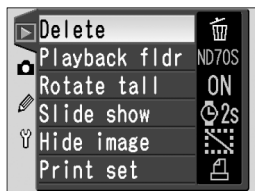

Option	
Delete	124–125
Playback fldr	126
Rotate tall	126
Slide show	127–128
Hide image	129
Print set	130–131

The playback menu is not displayed when no memory card is inserted.

Delete

To display the delete menu, highlight **Delete** and press the multi selector to the right. Press the multi selector up or down to highlight an option, then press to the right to make a selection.

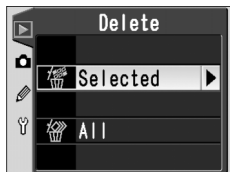

Option	Description
Selected	Delete selected photographs.
All	Delete all photographs.

High-Capacity Memory Cards

If the memory card contains a large number of files or folders and the number of pictures to be deleted is very large, deletion can sometimes take more than half an hour.

Protected and Hidden Images

Images marked with a icon are protected and can not be deleted. Hidden images (129) are not displayed in the thumbnail list and can not be selected for deletion.

Using the Multi Selector

The multi selector can be used at any time when the monitor is on. The focus selector lock switch only takes effect when the monitor is off.

Deleting Selected Photographs: *Selected*

Choosing **Selected** displays the photographs in the folder or folders selected in the **Playback fldr** menu (👁 126) as small thumbnail images.

1  Highlight image.

2  Select highlighted image. Selected image marked by 📄 icon.

3 Repeat steps 1 and 2 to select additional pictures. To deselect picture, highlight and press center of multi selector. To exit without deleting pictures, press **MENU** button.

4  Confirmation dialog displayed. Press multi selector up or down to highlight option, press **ENTER** to select.

- **Yes**: delete selected pictures
- **No**: exit without deleting images

Deleting All Photographs: *All*

Choosing **All** displays the confirmation dialog shown at right. Press the multi selector up or down to highlight an option, then press the **ENTER** button to make a selection.

- **Yes**: delete all images in the folder or folders selected in the **Playback fldr** menu (👁 126). Pictures that are protected or hidden will not be deleted.
- **No**: exit without deleting images.



Playback Fldr

To display the playback folder menu, highlight **Playback fldr** in the playback menu (👁 124) and press the multi selector to the right. Press the multi selector up or down to highlight an option, then press to the right to make a selection.

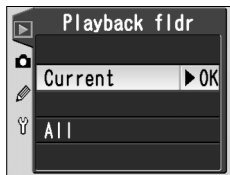

Option	Description
Current	Only images in folder currently selected for storage in setup Folders menu are displayed during playback (👁 156). This option is selected automatically when photo is taken. If memory card is inserted and this option selected before photos have been taken, message stating that folder contains no images will be displayed during playback. Select All to begin playback.
All	Images in all folders created by cameras that conform to Design Rule for Camera File System (DCF)—all Nikon digital cameras and most other makes of digital camera—will be visible during playback.

Rotate Tall

To choose whether photographs taken in “tall” (portrait) orientation are automatically rotated for display in the monitor, highlight **Rotate tall** in the playback menu (👁 124) and press the multi selector to the right. Press the multi selector up or down to highlight an option, then press to the right to make a selection.

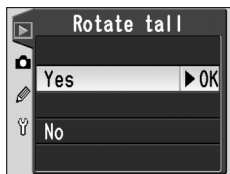

Option	Description
Yes (default)	“Tall” (portrait) orientation photos are displayed in tall orientation during playback (to fit in monitor, tall orientation photos are displayed at 2/3 the size of other photographs).
No	“Tall” (portrait) orientation photos are not played back in tall orientation.

Image Rotation (👁 168)

Photographs taken with **Off** selected for **Image rotation** are displayed in “wide” (landscape) orientation, regardless of the option selected for **Rotate tall**.

Slide Show

To play images back one after the other in an automated “slide show,” highlight **Slide show** in the playback menu (124) and press the multi selector to the right. Press the multi selector up or down to highlight an option, then press to the right to make a selection.

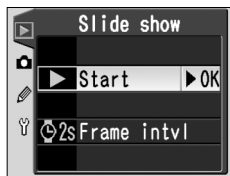

Option	Description
Start	Start slide show.
Frame intvl	Choose how long each picture will be displayed.

Starting the Slide Show: Start

Selecting **Start** starts an automated slide show. All photographs in the folder or folders selected in the **Playback fldr** menu (126) will be played back in the order recorded, with a pause between each image. Hidden photographs (129) will not be played back. The following operations can be performed during a slide show:

To	Press	Description
Go forward or back one frame		Press multi selector up to return to previous frame, down to skip to next frame.
View photo info		Press multi selector left or right to change photo info displayed during slide show.
Pause	ENTER	Press ENTER to pause slide show (128).
Exit to playback menu	MENU	Press MENU to end slide show and display playback menu.
Exit to playback mode		Press to end slide show and return to playback with current image displayed in monitor.
Exit to shooting mode	Shutter release	Press shutter-release button halfway to end slide show, turn monitor off, and return to shooting mode.

The dialog shown at right is displayed when the show ends or when the **ENTER** button is pressed to pause playback. Press the multi selector up or down to highlight an option, then press to the right to make a selection.

- **Restart:** Resume slide show.
- **Frame intvl:** Change the length of time each picture is displayed.

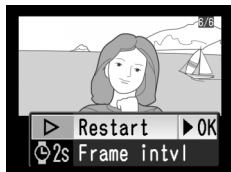

To exit the slide show and return to the playback menu, press the multi selector to the left or press the **MENU** button.

Changing the Display Interval: *Frame Intvl*

Selecting **Frame intvl** from the **Slide show** menu or the pause menu displays the menu shown at right. To change the length of time each image is displayed, press the multi selector up or down to highlight the appropriate option and then press the multi selector to the right to return to the previous menu.

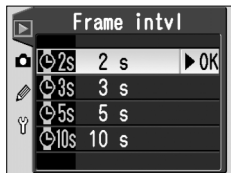

Hide Image

The **Hide image** option is used to hide or reveal selected photographs. Hidden images are visible only in the **Hide image** menu, and can only be deleted by formatting the memory card. Highlight **Hide image** in the playback menu (🔍 124) and press the multi selector to the right. The photographs in the folder or folders selected in the **Playback fldr** menu (🔍 126) will be displayed as small thumbnail images.



1

Highlight image.

2

Select highlighted image. Selected image marked by icon.

3 Repeat steps 1 and 2 to select additional pictures. To deselect picture, highlight and press center of multi selector. To exit without changing hidden status of pictures, press **MENU** button.

4

Complete operation and return to playback menu.

File Attributes for Hidden Images

Hidden images have “hidden” and “read-only” status when viewed on a Windows computer. In the case of photographs taken at an image quality of **NEF+JPEG Basic**, this marking applies to both the NEF (RAW) and JPEG image.

Protected and Hidden Images

Removing protection from an image that is both hidden and protected will simultaneously reveal the image.

Print Set

Print set is used to create a digital “print order” that lists the photographs to be printed, the number of copies, and the information to be included on each print. This information is stored on the memory card in **Digital Print Order Format (DPOF)**. The card can then be removed from the camera and used to print the selected images printed on any DPOF-compatible device.

Highlight **Print set** in the playback menu (📷 124) and press the multi selector to the right. Press the multi selector up or down to highlight an option, then press to the right to make a selection.



Option	Description
Select/set	Select photographs for printing.
Deselect all?	Remove all images from print order.

🔪 If “Print Set” Is Unavailable

If the **Print set** option is not available in the playback menu, there is not enough space on the memory card to store the print order. Delete some pictures and try again.

🔪 Taking Pictures for Direct Printing

When taking photographs to be printed without modification, choose **Direct Print** for **Optimize image** (📷 56) or select **Custom** and set **Color mode** to **Ia (sRGB)** or **IIIa (sRGB)**.

🔪 After Creating a Print Order

After creating a print order, do not change the hidden status of images in the print order or use a computer or other device to delete images. Either action could cause problems during printing.

🔪 DPOF







Digital Print Order Format (DPOF) is an industry-wide standard that allows pictures to be printed from print orders stored on the memory card. Before printing, check that the printer or print service supports DPOF.

🔪 Exif version 2.21

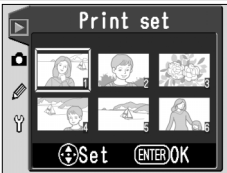
The D70S supports Exif (Exchangeable Image File Format for Digital Still Cameras) version 2.21, a standard that allows information stored with photographs to be used for optimal color reproduction when images are output on Exif-compliant printers.

Modifying the Print Order: *Select/Set*

Choosing **Select/set** displays the photographs in the folder or folders selected in the **Playback fldr** menu (126) as small thumbnail images.

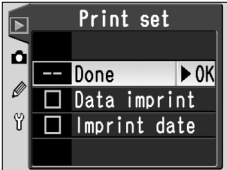
- 1**   Highlight image.
- 2**   Press multi selector up to select highlighted image and set number of prints to 1. Selected images are marked by  icon. Press multi selector up or down to specify number of prints (up to 99).
- 3** Repeat steps 1 and 2 to select additional pictures. To deselect picture, press multi selector down when number of prints is 1. To exit without changing print order, press  button.
- 4**   Complete print order and display menu of print options. Press multi selector up or down to highlight option.

 - To print shutter speed and aperture on all pictures in print order, highlight **Data imprint** and press multi selector to right. ✓ will appear next to item.
 - To print date of recording on all pictures in print order, highlight **Imprint date** and press multi selector to right. ✓ will appear next to item.
 - To deselect checked item, highlight and press multi selector to right.

To complete print order and return to playback menu, highlight **Done** and press multi selector to right. To exit without altering print order, press  button.

The shooting menu contains the following options:



Option	
Optimize image*	56–61
Long exp. NR	133
Image quality	41–42
Image size	43–45
White bal.*	48–55
ISO	46–47

* Available only when mode dial is set to **P**, **S**, **A**, or **M**.

Optimize Image

When the mode dial is set to **P**, **S**, **A**, or **M**, photographs are enhanced according to the option selected in the **Optimize image** menu. See “Taking Photographs: Optimizing Images” for details (56).

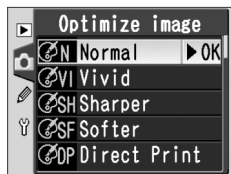

Using the Multi Selector

The multi selector can be used at any time when the monitor is on. The focus selector lock switch only takes effect when the monitor is off.

Long Exp. NR

This option controls whether photographs taken at shutter speeds slower than about 1 s are processed to reduce “noise” (randomly-spaced, brightly-colored pixels that appear at slow shutter speeds, particularly in shadows). Highlight **Long Exp. NR** in the shooting menu (132) and press the multi selector to the right. Press the multi selector up or down to highlight an option, then press to the right to make a selection.

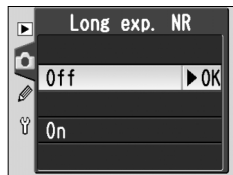

Option	Description
Off (default)	Noise reduction off; camera functions normally.
On	Noise reduction takes effect at shutter speeds of about 1 s or slower. Time required to process images more than doubles; if this option is selected in continuous shooting mode (62), frame rate will drop to under 3fps. During processing, job nr blinks in shutter-speed and aperture displays. Next photo can be taken when job nr is no longer displayed. <div style="text-align: center;"> </div>

The Memory Buffer

The maximum number of shots that can be stored in the memory buffer when noise reduction is on is as follows:

Image quality	Image size	No. of shots
RAW	—	3
FINE	L	7
	M	5
	S	17
NORM	L	10
	M	5
	S	25

Image quality	Image size	No. of shots
BASIC	L	17
	M	5
	S	47
RAW+BASIC	L	3

Image Quality

Image quality can be selected from the options shown at right. For more information, see “Taking Photographs: Image Quality and Size” (41).



Image Size

Image size can be selected from **L (3008 × 2000)**, **M (2240 × 1488)**, and **S (1504 × 1000)**. See “Taking Photographs: Image Quality and Size” (43) for more information.



White Bal.

This option is only available when the mode dial is rotated to **P**, **S**, **A**, or **M**. For more information, see “Taking Photographs: White Balance” (48).

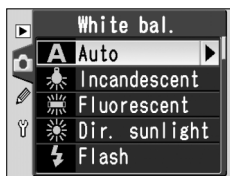

ISO

Sensitivity (ISO equivalency) can be raised above the default setting of ISO 200 equivalent. See “Taking Photographs: Sensitivity (ISO Equivalency)” (46) for details.



Custom Settings

Fine-Tuning Camera Settings

The Custom Settings (CSM) menu can be used to customize camera settings to suit individual preferences. When **Simple** is selected for the **CSM menu** option in the setup menu (🔍 161), the Custom Settings menu contains the following options:



Option	🔍
R Menu reset	136–137
01 Beep	138
02 Autofocus	139
03 AF-area mode	140
04 AF assist	141

Option	🔍
05 ISO auto	142–143
06 No CF Card?	143
07 Image review	144
08 Grid display	144
09 EV step	144

A further sixteen items are listed when **Detailed** is selected for **CSM menu**:

Option	🔍
10 Exp comp.	145
11 Center wtd	145
12 BKT set	146
13 BKT Order	146
14 Command dial	147
15 AE-L/AF-L	147
16 AE Lock	148
17 Focus area	148

Option	🔍
18 AF area illm	149
19 Flash mode	150–151
20 Flash sign	152
21 Shutter spd	152
22 Monitor off	153
23 Meter-off	153
24 Self-timer	153
25 Remote	154

The first and last items in each menu are linked. Pressing the multi selector down when **09 EV step** (simple view) or **25 Remote** (detailed view) is selected highlights **R Menu reset**. Pressing the multi selector up when **R Menu reset** is selected displays **09 EV step** or **25 Remote**.

🔍 Using the Multi Selector

The multi selector can be used at any time when the monitor is on. The focus selector lock switch only takes effect when the monitor is off.

The HELP Button

To view help on Custom Settings, press the **?** (HELP) button when an item is highlighted in the CSM menu or when the options for a Custom Setting are displayed.

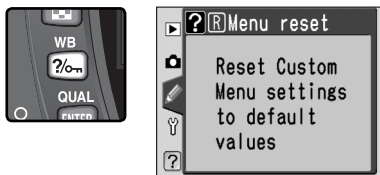

Custom Setting R: Menu Reset

To restore Custom Settings to default values, highlight **Menu reset** in the CSM menu (135) and press the multi selector to the right. Press the multi selector up or down to highlight an option, then press to the right to make a selection.

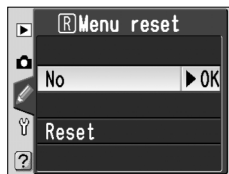

Option	Description
No (default)	Exit menu, leaving settings unchanged.
Reset	Restore settings to default values.





Two-Button Reset

Custom Settings are not reset when a two-button reset is performed (111).

Default settings are listed below.

Option	Default	Option	Default
R Menu reset	No	13 BKT Order	MTR>Under>Over
01 Beep	On	14 Command dial	No
02 Autofocus	AF-S*	15 AE-L/AF-L	AE/AF Lock
03 AF-area mode	Single area†	16 AE Lock	AE-L button
04 AF assist	On	17 Focus area	No wrap
05 ISO auto	Off	18 AF area illum	Auto
06 No CF Card?	Release locked	19 Flash mode	TTL
07 Image review	On	20 Flash sign	On
08 Grid display	Off	21 Shutter spd	1/60
09 EV step	1/3 Step	22 Monitor off	20s
10 Exp comp.	Off	23 Meter-off	6s
11 Center wtd	∅ 8mm	24 Self-timer	10s
12 BKT set	AE & flash	25 Remote	1 min

* Default for  mode is **AF-C**.

† Default for , , , , and  modes is **Closest subject**.

Custom Setting 1: Beep

To turn the camera speaker on or off, highlight **Beep** in the CSM menu (👁️ 135) and press the multi selector to the right. Press the multi selector up or down to highlight an option, then press to the right to make a selection.

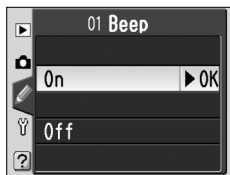

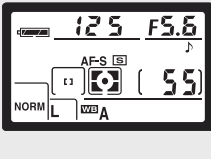
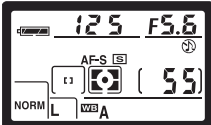
Option	Description
On (default)	Speaker on; 🗣️ displayed in control panel. Beep sounds while release timer is running (self-timer and delayed remote modes), when photo is taken in quick-response remote mode, or when camera has focused in single-servo AF (focus-mode selector set to AF and AF-S selected for Custom Setting 2). 
Off	Speaker off; beep does not sound. 🗣️ displayed in control panel. 

Custom Setting 2: Autofocus

To choose how the camera focuses when the focus-mode selector is set to **AF**, highlight **Autofocus** in the CSM menu (📷 135) and press the multi-selector to the right. Press the multi-selector up or down to highlight an option, then press to the right to make a selection.



Option	Description	
AF-S*	Single-servo AF (📷 64). Focus locks when in-focus indicator (●) appears in viewfinder; photographs can only be taken when camera is in focus. AF-S displayed in control panel when focus-mode selector is set to AF .	
AF-C†	Continuous-servo AF (📷 64). Camera focuses continuously while shutter-release button is pressed halfway; photographs can be taken even when camera is not in focus. AF-C displayed in control panel when focus-mode selector is set to AF .	

* Default for P, S, A, M, and modes. Custom Setting 2 automatically reset to **AF-S** when mode dial rotated to or .

† Default for mode. Custom Setting 2 automatically reset to **AF-C** when mode dial rotated to .

Custom Setting 3: AF-Area Mode

To choose how the focus area is selected when the focus-mode selector is set to **AF**, highlight **AF-area mode** in the CSM menu (135) and press the multi selector to the right. Press the multi selector up or down to highlight an option, then press to the right to make a selection.

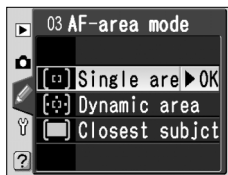

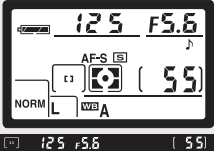
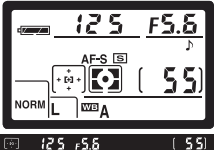
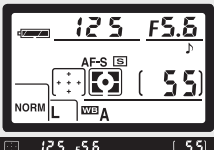
Option	Description
<p>[L]</p> <p>Single area^{1,2}</p>	<p>User selects focus area manually (86); camera focuses on subject in selected focus area only. Use for relatively static compositions with subjects that will stay in selected focus area. Also recommended with telephoto lenses or when subject is poorly lit.</p> 
<p>[+/-]</p> <p>Dynamic area¹</p>	<p>User selects focus area manually (86), but camera uses information from multiple focus areas to determine focus. If subject leaves selected focus area even briefly, camera will focus based on information from other focus areas (focus area selected in viewfinder does not change). Use when following erratically moving subjects and in other situations in which it is difficult to keep subject in selected focus area.</p> 
<p>[M]</p> <p>Closest subject^{3,4}</p>	<p>Camera automatically selects focus area containing subject closest to camera; active focus area highlighted when camera focuses (8). If subject leaves active focus area, camera will focus based on information from other focus areas. When AF-S is selected for Custom Setting 2 (Autofocus; 139), focus will lock once camera has focused. Prevents out-of-focus shots when photographing erratically moving subjects.</p> 

1 Control panel and viewfinder shown with center focus area selected.

2 Default for **P**, **S**, **A**, **M**, and **+** modes. Custom Setting 3 automatically reset to **Single area** when mode dial rotated to **+**.

3 Default for **AUTO**, **+**, **A**, **S**, **M**, and **+** modes. Custom Setting 3 automatically reset to **Closest subject** when mode dial rotated to **AUTO**, **+**, **A**, **S**, **M**, or **+**.

4 Active focus area displayed in viewfinder when camera focuses.

Custom Setting 4: AF Assist

To choose whether the built-in AF-assist illuminator lights to assist the focus operation when the subject is poorly lit, highlight **AF assist** in the CSM menu (📷 135) and press the multi selector to the right. Press the multi selector up or down to highlight an option, then press to the right to make a selection.







Option	Description
On (default)	AF-assist illuminator lights when conditions are appropriate (📷 72). AF-assist illuminator does not light when mode dial is set to 📷, 📷, or 📷.
Off	AF-assist illuminator off.

Custom Setting 5: ISO Auto

To choose whether the camera automatically adjusts sensitivity (ISO equivalency) as necessary to achieve optimal exposure and flash level, highlight **ISO auto** in the CSM menu (135) and press the multi selector to the right. Press the multi selector up or down to highlight an option, then press to the right to make a selection.



Option	Description
Off (default)	Sensitivity remains fixed at value selected by user (46), even if optimal exposure can not be achieved.
On	<p>If optimal exposure and flash level can not be achieved at sensitivity selected by user, sensitivity is adjusted to compensate, to minimum approximately equivalent to ISO 200 and a maximum approximately equivalent to ISO 1600. ISO AUTO icon is displayed in control panel and viewfinder; unless Speedlight is used, icon blinks when sensitivity is altered from value selected by user. Note that noise is more likely at high sensitivities.</p> <ul style="list-style-type: none"> • When mode dial is set to P, A, AUTO, , , , or : camera automatically adjusts sensitivity when shutter speed needed to obtain optimum exposure would be faster than $\frac{1}{8000}$s or slower than value specified for P, A, DVP mode (143; shutter speed may drop below specified value if optimal exposure can not be achieved at ISO 1600 equivalent). • When mode dial is set to S: camera automatically adjusts sensitivity when limits of camera exposure metering system are exceeded. • When mode dial is set to M: camera automatically adjusts sensitivity when optimum exposure can not be achieved at selected shutter-speed and aperture.

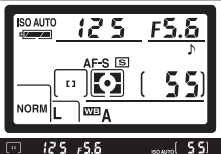

Using a Flash











When **ISO auto** is on, foreground subjects may be underexposed in flash photographs taken at slow shutter speeds, in daylight, or against a bright background. Choose a flash mode other than slow sync or select mode **A** or **M** and choose a larger aperture.

ISO Value

The value displayed for sensitivity (ISO equivalency) when the **ISO** button is pressed is the value selected by the user. The value shown when **ISO auto** is on may differ from the value actually used by camera.

Selecting **On** displays the menu shown at right. To accept the current setting for **P, A, DVP mode** and turn **ISO auto** on, highlight **Done** and press the multi selector to the right. The CSM menu will be displayed.



To change the shutter speed limit for **P, A, ^{AUTO} , , , , and ** modes, highlight **P, A, DVP mode** and press the multi selector to the right. Press the multi selector up or down to highlight a shutter speed between $\frac{1}{125}$ to 30s in steps equivalent to 1 EV and press the multi selector to the right to select the highlighted value and return to the CSM menu. In **P, A, ^{AUTO} , , , , , and ** modes, the camera will automatically raise sensitivity when the shutter speed needed to obtain optimum exposure would be slower than the selected value.

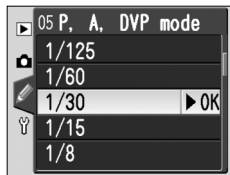

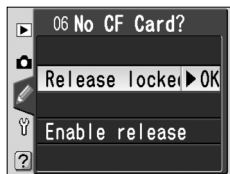

Custom Setting 6: No CF Card?

To choose whether the shutter can be released when no memory card is inserted in the camera, highlight **No CF Card?** in the CSM menu ( 135) and press the multi selector to the right. Press the multi selector up or down to highlight an option, then press to the right to make a selection.



Option	Description
Release locked (default)	Shutter-release button disabled when no memory card is inserted. Shutter release will not lock if Nikon Capture 4 version 4.2 or later (available separately) is being used to record photographs to computer.
Enable release	Shutter-release button enabled even when no memory card is inserted.

Custom Setting 7: Image Review

This option determines whether photographs are automatically displayed in the monitor after shooting (**On**, the default option) or only when the  button is pressed (**Off**). Highlight **Image review** in the CSM menu ( 135) and press the multi selector to the right. Press the multi selector up or down to highlight an option, then press to the right to make a selection. Regardless of the option selected, photographs can be viewed at any time by pressing the  button.

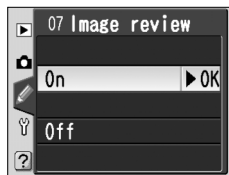

Custom Setting 8: Grid Display (On-Demand Grid Lines)

On-demand grid lines can be displayed in the viewfinder for reference when composing photographs, taking landscape shots, or shifting or tilting a PC Nikkor lens. To turn the grid-line display on or off, highlight **Grid display** in the CSM menu ( 135) and press the multi selector to the right. Press the multi selector up or down to highlight an option, then press to the right to make a selection. To display the grid, select **On**. The default setting is **Off** (no grid displayed).

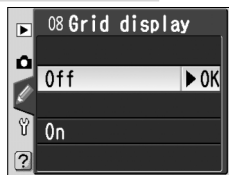



Custom Setting 9: EV Step







This option determines whether adjustments to shutter speed, aperture, exposure compensation, bracketing, and flash exposure compensation are made in increments equivalent to $\frac{1}{3}$ EV (**1/3 step**, the default option) or $\frac{1}{2}$ EV (**1/2 step**). Highlight **EV step** in the CSM menu ( 135) and press the multi selector to the right. Press the multi selector up or down to highlight an option, then press to the right to make a selection.





Custom Setting 10: Exp Comp.

This option controls whether the  button is needed to set exposure compensation in **P**, **S**, and **A** modes ( 86). Highlight **Exp comp.** in the detailed CSM menu ( 135) and press the multi-selector to the right. Press the multi-selector up or down to highlight an option, then press to the right to make a selection.



Option	Description			
Off (default)	Exposure compensation set by pressing  button and rotating main command dial.			
On	Exposure compensation set by rotating command dial only. Dial used depends on option selected for Custom Setting 14.			
	Custom Setting 14			
		No	Yes	
	Mode	P	Sub-command dial	Sub-command dial
		S	Sub-command dial	Main command dial
A		Main command dial	Sub-command dial	
This option has no effect in M ,  ,  ,  ,  ,  , and  modes.				

Custom Setting 11: Center Wtd

When calculating exposure, center-weighted metering (available in **P**, **S**, **A**, and **M** modes;  75) assigns the greatest weight to a circle in the center of the frame. The diameter (ϕ) of this circle can be selected from 6, 8, 10, and 12mm (the default option is 8mm). Highlight **Center wtd** in the detailed CSM menu ( 135) and press the multi-selector to the right. Press the multi-selector up or down to highlight an option, then press to the right to make a selection.

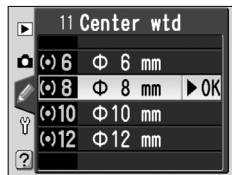

Custom Setting 12: *BKT Set*

This option controls what settings are affected when auto bracketing is in effect. Highlight **BKT set** in the detailed CSM menu (135) and press the multi selector to the right. Press the multi selector up or down to highlight an option, then press to the right to make a selection.

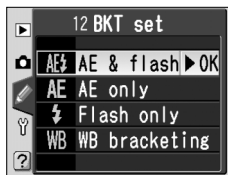

Option	Description
AE & flash (default)	Camera performs exposure and flash-level bracketing.
AE only	Camera performs exposure bracketing only.
Flash only	Camera performs flash-level bracketing only.
WB bracketing	Camera performs white balance bracketing.

Custom Setting 13: *BKT Order*

This option controls the order in which bracketing is performed. Highlight **BKT Order** in the detailed CSM menu (135) and press the multi selector to the right. Press the multi selector up or down to highlight an option, then press to the right to make a selection.



Option	Description
MTR>Under>Over (default)	Bracketing performed in order described in “Bracketing” (90, 93).
Under>MTR>Over	Bracketing proceeds in order from lowest to highest value.

White Balance Bracketing

White balance bracketing is not available at image qualities of **NEF (Raw)** or **NEF+JPEG Basic**.

Custom Setting 14: Command Dial

This option can be used to exchange the functions of the main and sub-command dials when setting shutter speed and aperture in **S**, **A**, and **M** modes. Highlight **Command dial** in the detailed CSM menu (🔍 135) and press the multi selector to the right. Press the multi selector up or down to highlight an option, then press to the right to make a selection.



Option	Description
No (default)	Main command dial controls shutter speed, sub-command dial aperture.
Yes	Main command dial controls aperture, sub-command dial shutter speed.

Custom Setting 15: AE-L/AF-L

This option controls the behavior of the **AE-L/AF-L** button. Highlight **AE-L/AF-L** in the detailed CSM menu (🔍 135) and press the multi selector to the right. Press the multi selector up or down to highlight an option, then press to the right to make a selection.



Option	Description
AE/AF Lock (default)	Both focus and exposure lock while AE-L/AF-L button is pressed.
AE Lock only	Exposure locks while AE-L/AF-L button is pressed. Focus is unaffected.
AF Lock only	Focus locks while AE-L/AF-L button is pressed. Exposure is unaffected.
AE Lock hold	Exposure locks when AE-L/AF-L button is pressed and remains locked until button is pressed again or exposure meters turn off.
AF-ON	Camera focuses when AE-L/AF-L button is pressed. Camera does not focus when shutter-release button is pressed halfway.
FV Lock	Flash level locks when AE-L/AF-L button is pressed and remains locked until button is pressed again or exposure meters turn off (🔍 103).

Custom Setting 16: AE Lock

This option controls whether exposure locks while the shutter-release button is pressed halfway. Highlight **AE Lock** in the detailed CSM menu (135) and press the multi selector to the right. Press the multi selector up or down to highlight an option, then press to the right to make a selection.



Option	Description
AE-L button (default)	Exposure can only be locked by pressing AE-L/AF-L button.
+Release btnn	Exposure can be locked by pressing AE-L/AF-L button or by pressing shutter-release button halfway.

Custom Setting 17: Focus Area

By default, the focus-area display is bounded by the four outer focus areas so that, for example, pressing the multi selector up when the top focus area is selected has no effect. Focus-area selection can be changed to “wrap around” from top to bottom, bottom to top, right to left, and left to right. Highlight **Focus area** in the detailed CSM menu (135) and press the multi selector to the right. Press the multi selector up or down to highlight an option, then press to the right to make a selection.



Option	Description
No wrap (default)	Wrap-around disabled.
Wrap	Wrap-around enabled.

Custom Setting 18: AF Area Illm

This option controls whether or not the active focus area is highlighted in red in the viewfinder. Highlight **AF area illm** in the detailed CSM menu (👁 135) and press the multi selector to the right. Press the multi selector up or down to highlight an option, then press to the right to make a selection.





Option	Description
Auto (default)	Selected focus area is automatically highlighted as needed to provided contrast with background.
Off	Selected focus area is not highlighted.
On	Selected focus area is always highlighted, regardless of brightness of background. Depending on brightness of background, selected focus area may be difficult to see.

Custom Setting 19: Flash Mode

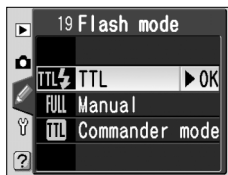
To choose the flash mode for the built-in Speedlight, highlight **Flash mode** in the detailed CSM menu (135) and press the multi selector to the right. Press the multi selector up or down to highlight an option, then press to the right to make a selection.



Option	Description
TTL (default)	Output of built-in Speedlight is adjusted automatically in response to shooting conditions.
Manual	<p>Menu at right will be displayed. Highlight setting between Full (full power) and 1/16 ($1/16$ of full power) and press multi selector to right to return to CSM menu. When mode dial is set to P, S, A, or M, flash will fire at chosen fraction of full power whenever built-in Speedlight is raised (at full power, built-in Speedlight has GN [m/ft] of 17/56 [ISO 200] or 12/39 [ISO 100]).  icons blink in control panel and viewfinder. No monitor preflash is emitted, allowing built-in Speedlight to function as master flash for optional slave flash units.</p>
Commander mode	<p>Choose this option to allow camera to control flash level when one or more SB-800 or SB-600 Speedlights are used for wireless flash photography in P, S, A, or M mode. Menu at right will be displayed; choose TTL (i-TTL flash control, available only with CPU lens), AA (Auto Aperture, available only when CPU lens is used with SB-800), or M (Manual). Selecting M displays menu shown at right; press multi selector up or down to choose output level for wireless flash unit from values between FULL (full power) and 1/128 ($1/128$ of full power). Press multi selector to right to return to CSM menu.</p> <p>* If Commander mode is selected,  will not be displayed in flash sync mode icon when built-in Speedlight is raised.</p>

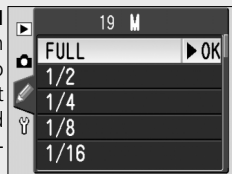
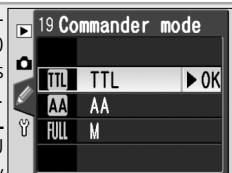
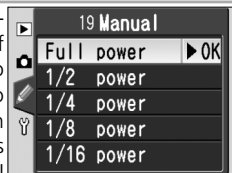

Commander Mode

When using optional SB-800 or SB-600 Speedlights with **Commander mode** selected for Custom Setting 19 (**Flash mode**), set the optional Speedlights to Channel 3, Group A and position them as shown below.

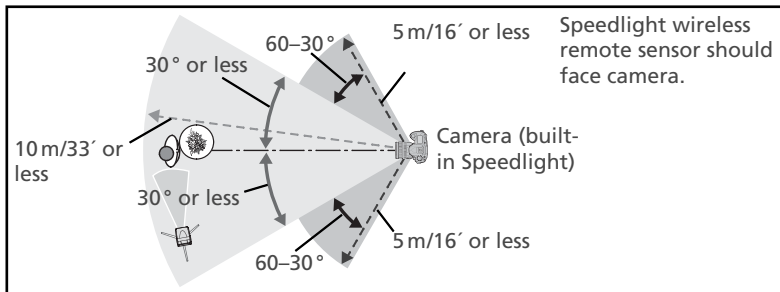

The maximum distance between the optional Speedlights and the camera is about 10 m (33') when the Speedlight is positioned in front of the camera (within 30° on either side of the center line), or about 5 m (16') when the Speedlight is to the side (30–60° to either side of the center line).



Commander Mode

Press the **Q** button to raise the built-in Speedlight. Position the sensor windows on the optional Speedlights where they will pick up the monitor preflashes from the built-in Speedlight (take particular care when not using a tripod). Be sure that direct light or strong reflections from the optional Speedlights do not enter the camera lens (in TTL mode) or the photocell on the optional Speedlight (AA mode), as this may interfere with exposure. To prevent the timing flashes emitted by the built-in Speedlight from appearing in photographs taken at short ranges, use a low sensitivity and small aperture (large f-number) and choose a flash sync mode other than rear-curtain sync. After positioning the Speedlights, take a test shot and view the results in the camera monitor.

Although there is no limit on the number of optional Speedlights that may be used, the practical maximum is three. With more than this number, the light emitted by the other flash units will interfere with performance. All Speedlights must be in the same group; flash compensation (102) applies to all Speedlights. See the Speedlight manual for more information.



Commander mode settings of **AA** (SB-800 only) and **TTL** are available with CPU lenses only. If a non-CPU lens is attached, the shutter release will be disabled. The flash-ready indicator (⚡) in the viewfinder and the ⚡ icon and borders of the flash sync mode indicator in the control panel will blink.

Custom Setting 20: Flash Sign

In **P**, **S**, **A**, and **M** modes, the built-in Speedlight does not pop up automatically. This option determines whether the  indicator in the viewfinder flickers to warn that the built-in Speedlight is required for additional lighting when the shutter-release button is pressed halfway. Highlight **Flash sign** in the detailed CSM menu ( 135) and press the multi selector to the right.

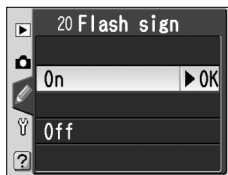
Press the multi selector up or down to highlight an option, then press to the right to make a selection.



Option	Description
On (default)	 indicator flickers to warn that built-in Speedlight is required (P , S , A , and M modes only).  indicator not displayed when built-in Speedlight is raised or optional Speedlight is attached.
Off	 indicator does not flicker when built-in Speedlight is required.

Custom Setting 21: Shutter Spd

This option determines the slowest shutter speed possible when using a flash with the mode dial set to **P** or **A**. Options range from $\frac{1}{60}$ s (**1/60**, the default setting) to 30s (**30"**). Highlight **Shutter spd** in the detailed CSM menu ( 135) and press the multi selector to the right. Press the multi selector up or down to highlight an option, then press to the right to make a selection.

Regardless of the setting chosen, shutter speeds as slow as 30s are always available when the flash sync mode is set to slow sync.

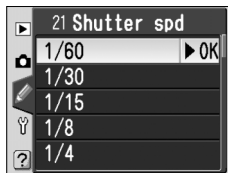

Custom Setting 22: Monitor Off

This option controls how long the monitor remains on when no operations are performed: 10s, 20s (the default option), 1 minute, 5 minutes, or 10 minutes. Highlight **Monitor off** in the detailed CSM menu (135) and press the multi selector to the right. Press the multi selector up or down to highlight an option, then press to the right to make a selection. Choose a shorter monitor-off delay for longer battery life.



Custom Setting 23: Meter-Off

This option controls how long the camera continues to meter exposure when no operations are performed: 4s, 6s (the default option), 8s, 16s, or 30 minutes. Highlight **Meter-off** in the detailed CSM menu (135) and press the multi selector to the right. Press the multi selector up or down to highlight an option, then press to the right to make a selection. Choose a shorter meter-off delay for longer battery life.

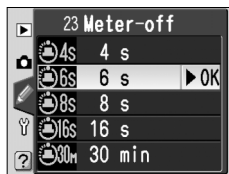

Custom Setting 24: Self-Timer

This option controls the length of the shutter-release delay in self-timer mode. Shutter-release can be delayed by approximately 2s, 5s, 10s, (the default option), or 20s. Highlight **Self-timer** in the detailed CSM menu (135) and press the multi selector to the right. Press the multi selector up or down to highlight an option, then press to the right to make a selection.



The EH-5 AC Adapter

When the camera is powered by an optional EH-5 AC adapter, exposure meters will not turn off and the monitor will only power off after ten minutes, regardless of the options chosen for Custom Settings 22 (**Monitor off**) and 23 (**Meter-off**).

Custom Setting 25: Remote

This option controls how long the camera will continue to wait for a signal from the remote control when no operations are performed in delayed remote or quick-response remote modes: 1 minute (the default option), 5 minutes, 10 minutes, or 15 minutes. If no signal is received in the specified period or the camera is turned off, the camera will revert to single-frame or continuous mode (whichever was last in effect).



Highlight **Remote** in the detailed CSM menu (▶ 135) and press the multi selector to the right. Press the multi selector up or down to highlight an option, then press to the right to make a selection.

The Setup Menu

Camera Setup

The setup menu contains three pages of options:

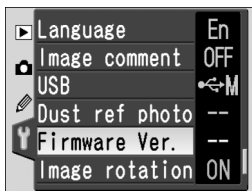

Option	
Folders	156–158
File No. Seq.	159
Format	160
CSM menu	161
Date	161
LCD brightness	161
Mirror lock-up	162
Video mode	162
Language	163
Image comment	163–164
USB	165
Dust ref photo	166–167
Firmware Ver.	167
Image rotation	168

Using the Multi Selector

The multi selector can be used at any time when the monitor is on. The focus selector lock switch only takes effect when the monitor is off.

Folders

To create and manage folders, or to choose the folder in which photographs will be stored, highlight **Folders** in the setup menu (155) and press the multi selector to the right. Press the multi selector up or down to highlight an option, then press to the right to make a selection.



Option	Description
Select folder	Select existing folder for storage.
New	Create new folder with five-letter folder name.
Rename	Rename existing folder.
Delete	Delete empty folders.

Select Folder

To select the folder in which subsequent images will be stored, highlight **Select folder** in the **Folders** menu and press the multi selector to the right. Press the multi selector up or down to highlight a folder, then press to the right to select the folder and return to the setup menu. The selected folder will also be used for playback when

Current is selected in the **Playback fldr** menu (126).



The folder currently selected is listed first, followed by ND70S (the default folder), followed by the remaining folders in alphabetical order. The folder selected in the **Select folder** menu does not change even when the folder is deleted or a new memory card is inserted. A folder with the same name will be created when a photograph is taken.

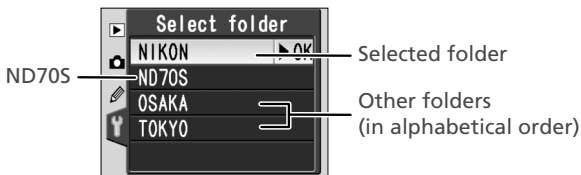

New

To create a new folder, highlight **New** in the **Folders** menu and press the multi selector to the right. The dialog shown in Step 1 will be displayed.

- 1 Enter a five letter folder name as described below.



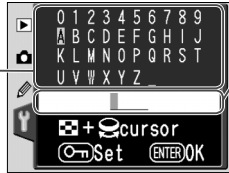

Keyboard area

Use multi selector to highlight letters, press  button to select.





Name area

Folder name appears here. To move cursor, press  button and rotate main command dial.

To move the cursor in the name area, press the  button and rotate the main command dial. To enter a new letter at the current cursor position, use the multi selector to highlight the desired character in the keyboard area and press the  button. To delete the character at the current cursor position, press the  button. To return to the setup menu without creating a new folder, press the  button.

Folder names can be up to five characters long. Any characters after the fifth will be deleted.

- 2 Press the  button to create the folder and return to the setup menu. Until another folder is selected, all subsequent photographs will be stored in the new folder. The folder will also be used for playback when **Current** is selected in the **Playback fldr** menu ( 126).

Folder Names

On the memory card, folder names are preceded by a three-digit folder number assigned automatically by the camera (e.g., 100ND70S). Each folder can contain up to 999 photographs. If a photograph is taken when the current folder contains 999 files or a picture numbered 9999, the camera will create a new folder by adding one to the current folder number (e.g., 101ND70S). For the purposes of selection and naming, all folders with the same name are treated as the same folder. For example, if the folder NIKON is selected, pictures in all folders named NIKON (100NIKON, 101NIKON, 102NIKON, etc.) will be visible when **Current** is selected in the **Playback fldr** menu ( 126). Renaming similarly applies to all folders with the same name. During shooting, pictures are stored in the highest-numbered folder with the selected name.

Rename

To rename an existing folder, highlight **Rename** in the **Folders** menu and press the multi selector to the right.

1 A list of existing folders will be displayed. Press multi selector up or down to highlight a folder name.



2 Press the multi selector to the right. The dialog shown at right will be displayed. Edit the folder name as described in Step 1 on the preceding page. To exit to the setup menu without changing the folder name, press the **MENU** button.



3 Press the **ENTER** button to rename the folder and return to the setup menu.

Delete

To delete any folders on the memory card that contain no photographs, highlight **Delete** in the **Folders** menu and press the multi selector to the right. The dialog shown at right will be displayed; press the multi selector up or down to highlight an option, then press to the right to select.



- **No:** Exit to setup menu without deleting empty folders.
- **Yes:** Delete empty folders and return to setup menu.

Number of Folders

Additional time will be required for recording and playback if the memory card contains a very large number of folders.

File No. Seq.

When a photograph is taken, the camera names the new file by adding one to the last file number used. This option controls whether file numbering continues from the last number used when a new folder is created, the memory card is formatted, or a new memory card is inserted in the camera.

Highlight **File No. Seq.** in the setup menu (155) and press the multi selector to the right.

Press the multi selector up or down to highlight an option, then press to the right to make a selection.



Option	Description
Off (default)	File numbering reset to 0001 when new folder is created, memory card is formatted or new memory card is inserted in camera.
On	When new folder is created, memory card is formatted, or new memory card inserted in camera, file numbering continues from last number used. If photograph is taken when current folder contains photograph numbered 9999, new folder will be created automatically and file numbering will begin again from 0001.
Reset	As for On , except file numbering is reset to 0001 with next photograph taken (new folder will be created if current folder already contains photographs).

File Numbering

If the current folder is numbered 999 and contains 999 photographs or a photograph numbered 9999, the shutter release will be disabled. If **File No. Seq.** is on, turn it off, then format the memory card or insert another memory card in the camera.

Format

Memory cards must be formatted before first use. Formatting memory cards is also an effective way of deleting all pictures on the card. To format a memory card, highlight **Format** in the setup menu (155) and press the multi selector to the right. Press the multi selector up or down to highlight one of the following options and then press the **ENTER** button:

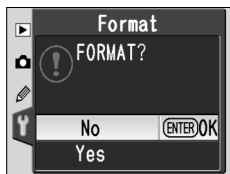

Option	Description
No	Exit without formatting memory card.
Yes	Format memory card. Message shown at right displayed while formatting is in progress. <i>Do not turn camera off, remove battery or memory card, or unplug the AC adapter (available separately) until formatting is complete and setup menu is displayed.</i>



✓ During Formatting

Do not remove the memory card, remove the battery, or unplug the AC adapter (available separately) while formatting is in progress.

✎ Before Formatting

Formatting memory cards permanently deletes all data they contain, including hidden and protected pictures and any other data that may be on the card. Before formatting, be sure to transfer to a computer any pictures you would like to keep.

✎ FAT 32

The D70S supports FAT 32, allowing use of memory cards with capacities of over 2 GB. FAT 16 is used when reformatting cards already formatted in FAT 16.

🔍 Two-Button Format

Memory cards can also be formatted with the **FORMAT** (🔍) and (🔍) buttons (21).

CSM Menu

To choose whether the CSM menu lists all twenty-six Custom Settings or only the first ten options, highlight **CSM menu** in the setup menu (155) and press the multi selector to the right. Press the multi selector up or down to highlight an option, then press to the right to make a selection.



Option	Description
Simple (default)	<p>CSM menu contains only items listed below. Changes can not be made to other Custom Settings while this option is in effect.</p> <ul style="list-style-type: none"> • R: Menu reset • 1: Beep • 2: Autofocus • 3: AF-area mode • 4: AF assist • 5: ISO auto • 6: No CF Card? • 7: Image review • 8: Grid display • 9: EV step
Detailed	CSM menu lists all twenty-six options (R–25).

Date

To set the camera clock to the current date and time, highlight **Date** in the setup menu (155) and press the multi selector to the right. See “First Steps: Basic Setup” Step 4 for details (16). The **Date** menu is displayed automatically the first time the camera is turned on.



LCD Brightness

To adjust monitor brightness, highlight **LCD brightness** in the setup menu (155) and press the multi selector to the right. The menu shown at right will be displayed. Press the multi selector up to increase brightness, down to decrease. The number at the bottom of the display indicates the current brightness level, with +2 the brightest setting and –2 the darkest. Press the multi selector to the right to complete the operation and return to the setup menu.

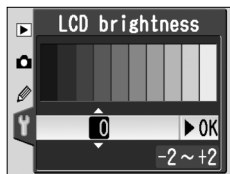

Mirror Lock-Up

This option is used to lock the mirror in the up position to allow inspection or cleaning of the low-pass filter that protects the CCD image sensor. See “Technical Notes: Caring for the Camera” (📖 194). Highlight **Mirror lock-up** in the setup menu (📖 155) and press the multi selector to the right. Press the multi selector up or down to highlight an option, then press to the right to make a selection.



Option	Description
Yes	When shutter is released, mirror is locked in up position and blinking “----- --” is displayed in control panel. Mirror will return to down position when camera is turned off. To ensure power is available to lower mirror, Nikon recommends using this option only when camera is powered by EH-5 AC adapter.
No	Mirror functions normally.

Video Mode

Before connecting the camera to a video device such as a television or VCR (📖 170), choose a video mode setting that matches the video standard used in the device. Highlight **Video mode** in the setup menu (📖 155) and press the multi selector to the right. Press the multi selector up or down to highlight an option, then press to the right to make a selection.



Option	Description
NTSC	Use when connecting camera to NTSC devices.
PAL	Use when connecting camera to PAL devices. Note that number of pixels in output is selectively reduced, causing drop in resolution.

📖 Video Output

The default video standard varies with the country or region of purchase.

Language

To change the language in which camera menus and messages are displayed, highlight **Language** in the setup menu (155) and press the multi selector to the right. See “First Steps: Basic Setup” Step 1 for details (16). The **Language** menu is displayed automatically the first time the camera is turned on.



Image Comment

Using this option, brief text comments can be added to photographs as they are taken. Comments can be viewed when the photographs are displayed using PictureProject or Nikon Capture 4 version 4.2 or later. Highlight **Image comment** in the setup menu (155) and press the multi selector to the right. Press the multi selector up or down to highlight an option, then press to the right to make a selection.

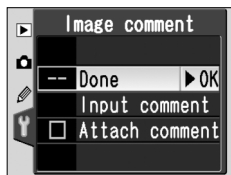

Option	Description
Done	Save comment and return to setup menu.
Input comment	Edit comment.
Attach comment	Attach comment to all new photographs.

Input Comment

To edit the image comment, highlight **Input comment** and press the multi selector to the right. The following dialog will be displayed.





Keyboard area

Use multi selector to highlight letters, press  button to select.



Comment area

Comment appears here. To move cursor, press  button and rotate main command dial.

To move the cursor in the comment area, press the  button and rotate the main command dial. To enter a new letter at the current cursor position, use the multi selector to highlight the desired character in the keyboard area and press the  button. To delete the character at the current cursor position, press the  button. To return to the setup menu without changing the comment, press the  button.

Comments can be up to thirty-six characters long. Any characters after the thirty-sixth will be deleted.

After editing the comment, press the  button to return to the image comment menu.

Attach Comment

To add the comment to all subsequent photographs, highlight **Attach comment** in the input comment menu and press the multi selector to the right. A  will appear in the box next to **Attach comment**; highlight **Done** and press the multi selector to the right to return to the setup menu.

To prevent the comment from being added to photographs, highlight **Attach comment** in the input comment menu and press the multi selector to the right to remove the check from **Attach comment**, then highlight **Done** and press the multi selector to the right to return to the setup menu.

USB

Before connecting the camera to a computer or printer via USB (🔗 171, 176), select the appropriate USB option. When connecting the camera to a PictBridge printer or using the Camera Control component of Nikon Capture 4 (available separately; version 4.2 or later required), select **PTP**. When using PictureProject to transfer (copy) pictures to the computer, choose an option according to the computer operating system as shown below.

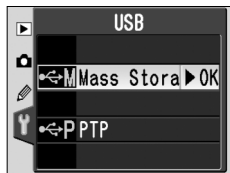

Windows XP Home Edition Windows XP Professional	Choose PTP or Mass Storage
Mac OS X	
Windows 2000 Professional Windows Millennium Edition (Me) Windows 98 Second Edition (SE)	Choose Mass Storage

The default setting for **USB** is **Mass Storage**. To change the USB setting, highlight **USB** in the setup menu (🔗 155) and press the multi selector to the right. Press the multi selector up or down to highlight the desired option, then press the multi selector to the right.

Dust Ref Photo

This option is used to acquire reference data for the Image Dust Off function in Nikon Capture 4 version 4.2 or later (available separately; for more information on Image Dust Off, see the *Nikon Capture 4 User's Manual*).

To acquire Image Dust Off reference data:



- 1 Attach a CPU lens. **Dust ref photo** is only available when a CPU lens is mounted on the camera. We recommend using a lens with a focal length of at least 50 mm. If using a zoom lens, zoom in to the maximum telephoto position.
- 2 Highlight **Dust ref photo** in the setup menu (📷 155) and press the multi selector to the right. The menu shown at right will be displayed.
 
- 3 Highlight **Yes** and press the multi selector to the right (to exit to the setup menu without acquiring Image Dust Off reference data, highlight **No** and press the multi selector to the right). Camera settings will automatically be adjusted for Image Dust Off. The message shown at right will be displayed, and **rEF** will be displayed in the viewfinder and control panel. To cancel the operation and return to the setup menu, press the **MENU** button or press the multi selector to the left. The operation will also be cancelled when the camera or monitor is turned off.
 

Image Dust Off

The Image Dust Off feature in Nikon Capture 4 (available separately) processes NEF (RAW) photographs to remove the effects of dust in the camera imaging system by comparing the images to the data acquired with **Dust ref photo**. It is not available with JPEG images. The D70S can be used with Nikon Capture 4 version 4.2 or later.

- 4 Position the lens ten centimeters (four inches) from a bright, featureless white object. After framing the object so that nothing else is visible in the viewfinder, press the shutter-release button halfway. In autofocus mode, focus will automatically be set to infinity; in manual focus mode, set focus to infinity manually before pressing the shutter-release button.
- 5 Press the shutter-release button the rest of the way down to acquire Image Dust Off reference data (note that noise reduction turns on automatically when the subject is poorly lit, increasing the amount of time needed to record the data). The monitor turns off when the shutter-release button is pressed.

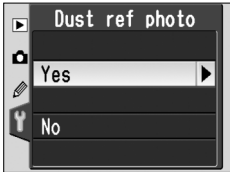
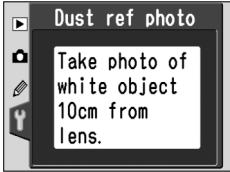
If the reference object is too bright or too dark, the camera may be unable to acquire Image Dust Off reference data and the message shown at right will be displayed. Choose another reference object and repeat the process from Step 3.

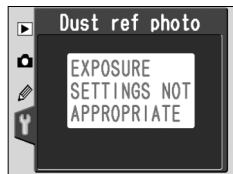

Firmware Ver.

To display the current camera firmware version, highlight **Firmware Ver.** in the setup menu (▶ 155) and press the multi selector to the right. Press the multi selector to the left to return to the setup menu.

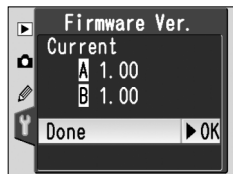

Image Dust Off Reference Data

When Image Dust Off reference data are viewed on the camera, the grid pattern shown at right appears in the monitor; histogram and highlights are not displayed. Files created with **Dust ref photo** can not be viewed using ordinary imaging software.

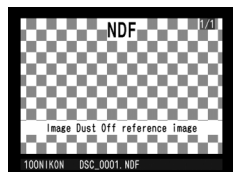
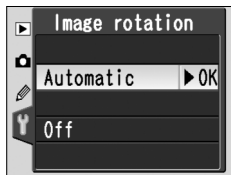





Image Rotation

By default, the D70S records camera orientation with each photograph taken. This allows “tall” (portrait) orientation photographs to be displayed in the correct orientation when played back on the camera or viewed using Nikon Capture 4 version 4.2 or later (available separately) or PictureProject. If desired, this feature can be turned off while taking photographs with the lens pointed up or down, when the camera may fail to record the correct orientation. Highlight **Image rotation** in the setup menu (M 155) and press the multi selector to the right. Press the multi selector up or down to highlight the desired option, then press the multi selector to the right.



Option	Description
Automatic (default)	Camera records whether shots are in landscape (wide) orientation, portrait (tall) orientation with the camera rotated 90° clockwise, or portrait (tall) orientation with the camera rotated 90° counter-clockwise.* <div style="display: flex; justify-content: space-around; align-items: center; margin-top: 10px;"> <div style="text-align: center;">  <p>Landscape (wide) orientation</p> </div> <div style="text-align: center;">  <p>Camera rotated 90° clockwise</p> </div> <div style="text-align: center;">  <p>Camera rotated 90° counter-clockwise</p> </div> </div>
Off	Camera orientation is not recorded. Nikon Capture 4 version 4.2 or later and PictureProject display all photographs in landscape (wide) orientation, and camera rotation icon in Nikon Capture 4 Camera Control shows camera in horizontal (landscape) orientation. Choose this option when taking photographs with lens pointing up or lens pointing down.

* In continuous mode (M 62), orientation recorded for first shot applies to all images in same burst, even if camera orientation is changed during shooting.

Rotate Tall (M 126)

“Tall” orientation photographs taken with **Automatic** selected for image rotation will only be displayed in tall orientation in the camera monitor if **Yes** is selected for **Rotate tall**.

Connections

Connecting to External Devices

Television Playback



170



Connecting to a Computer



171-174



Photographs and camera menus can be displayed on a television screen or recorded to video tape. If the PictureProject software provided with the camera is installed, the camera can be connected to a computer and photographs copied to disk for editing, viewing, printing, or long-term storage.

Television Playback

Read this section for information on connecting the camera to a television or VCR.

Connecting to a Computer

This section describes how to connect the camera to a computer.

Television Playback

Connecting the Camera to a Video Device

The supplied EG-D100 video cable can be used to connect the D70S to a television or VCR for playback or recording.

1 Turn the camera off.

✓ The EG-D100

Turn the camera off before connecting or disconnecting the EG-D100.

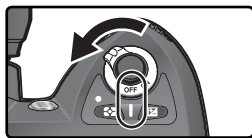

2 Open the cover protecting the video-out and DC-in connectors.



3 Connect the EG-D100 as shown.

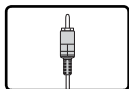

Connect to video device

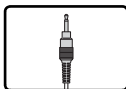
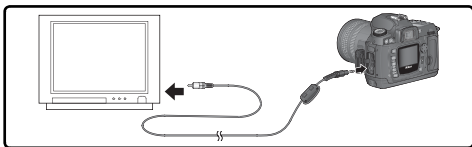

Connect to camera

4 Tune the television to the video channel.

5 Turn the camera on. The image normally shown in the monitor will be displayed on the television or recorded to video tape. The camera monitor will remain blank, but the camera will function normally in all other respects.

Use an AC Adapter

Use of an EH-5 AC adapter (available separately) is recommended for extended playback. When the EH-5 is connected, the camera monitor-off delay will be fixed at ten minutes and the exposure meters will no longer turn off automatically.

Video Output 162

Be sure that the video standard matches the standard used in the video device. Note that resolution will drop when images are output on a PAL device.

Connecting to a Computer

Data Transfer and Camera Control

The supplied UC-E4 USB cable can be used to connect the camera to a computer. Once the camera is connected, the supplied PictureProject software can be used to copy photographs to the computer, where they can be browsed, viewed, and retouched. The camera can also be used with Nikon Capture 4 version 4.2 or later (available separately), which supports batch processing and more advanced image editing options and can be used to control the camera directly from the computer.

Before Connecting the Camera

Install the necessary software after reading the manuals and reviewing the system requirements. To ensure that data transfer is not interrupted, be sure the camera battery is fully charged. If in doubt, charge the battery before use or use an EH-5 AC adapter (available separately).

Before connecting the camera, set the USB option in the setup menu (▶ 165) according to the computer operating system and whether the camera is being controlled using Nikon Capture 4 Camera Control or photographs are being transferred to the computer using PictureProject:

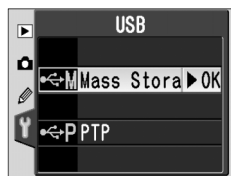

Operating system	PictureProject	Camera Control*
Windows XP Home Edition Windows XP Professional Mac OS X	Choose PTP or Mass Storage	Choose PTP
Windows 2000 Professional Windows Millennium Edition (Me) Windows 98 Second Edition (SE)	Choose Mass Storage	
Mac OS 9	Not supported	

* Camera Control for D70S available with Nikon Capture 4 version 4.2 or later.

Connecting the USB Cable

1 Turn the computer on and wait for it to start up.

2 Turn the camera off.



3 Connect the UC-E4 USB cable as shown below. Connect the camera directly to the computer; do not connect the cable via a USB hub or keyboard.

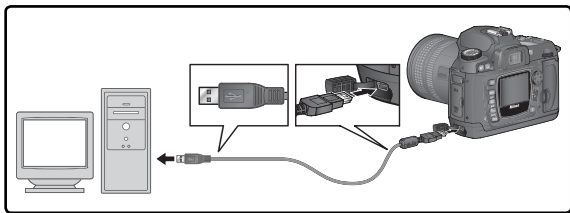

Windows 2000 Professional, Windows Millennium Edition (Me), Windows 98 Second Edition (SE)

Do NOT select **PTP** when using PictureProject under one of the above operating systems. If the camera has been connected to a computer running one of the above operating systems with **PTP** selected, the Windows hardware wizard will be displayed. Click **Cancel** to exit the wizard, and then disconnect the camera. Be sure to select **Mass Storage** before reconnecting the camera.

4 Turn the camera on.

If **Mass Storage** is selected for **USB**, **P** **Σ** will be displayed in the control panel and viewfinder (if **PTP** is selected, the camera displays will only change when Nikon Capture 4 Camera Control is running). Photographs can be transferred to the computer using PictureProject. For more information, see the *PictureProject Reference Manual* (on CD).

If the Nikon Capture 4 Camera Control component is running, the control panel and viewfinder will show **P** **Σ** in place of the number of exposures remaining. Any photographs taken will be recorded to the computer hard disk rather than the camera memory card. See the *Nikon Capture 4 User's Manual* for more information.

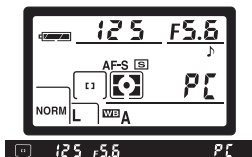

Do Not Turn the Camera Off

Do not turn the camera off while transfer is in progress.

Disconnecting the Camera

If **PTP** is selected for **USB** (🔌 165), the camera can be turned off and the USB cable disconnected once transfer is complete. If the **USB** option in the camera setup menu is still at its default setting of **Mass Storage**, the camera must first be removed from the system as described below.

Windows XP Home Edition/Windows XP Professional

Click the “Safely Remove Hardware” icon (🔌) in the taskbar and select **Safely remove USB Mass Storage Device** from the menu that appears.



Windows 2000 Professional

Click the “Unplug or Eject Hardware” icon (🔌) in the taskbar and select **Stop USB Mass Storage Device** from the menu that appears.



Windows Millennium Edition (Me)

Click the “Unplug or Eject Hardware” icon (🔌) in the taskbar and select **Stop USB Disk** from the menu that appears.



Windows 98 Second Edition (SE)

In My Computer, click with the right mouse button on the removable disk corresponding to the camera and select **Eject** from the menu that appears.

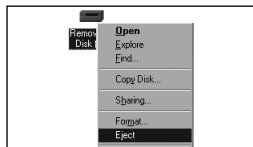

Macintosh

Drag the camera volume (“NIKON D70S”) into the Trash.

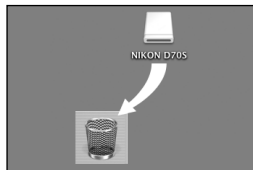

Printing Photographs

Connecting to a PictBridge Printer

When the camera is connected to a PictBridge-compatible printer, photographs can be printed directly from the camera.

When the camera is connected to a PictBridge-compatible printer via the supplied UC-E4 USB cable, selected JPEG photographs can be printed directly from the camera (RAW photographs can not be printed using this method). Before connecting the printer, confirm that it supports PictBridge. To ensure that printing is not interrupted, be sure the camera battery is fully charged. If in doubt, charge the battery before use or use an EH-5 AC adapter (available separately).

- 1 Set the **USB** option in the setup menu (M/165) to **PTP** (photographs can not be printed at the default setting of **Mass Storage**).

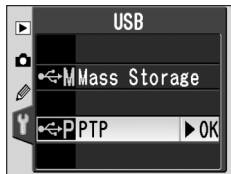

- 2 Turn the printer on.

- 3 Turn the camera off.



- 4 Connect the UC-E4 USB cable as shown below. Connect the camera directly to the printer; do not connect the cable via a USB hub.

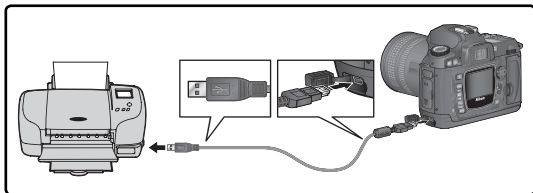

✎ Taking Pictures for Direct Printing

When taking photographs to be printed without modification, choose **Direct Print** for **Optimize image** (M/56) or select **Custom** and set **Color mode** to **Ia (sRGB)** or **IIIa (sRGB)**.

✎ Printing Times

Printing times will vary with the number of pictures printed and their size.

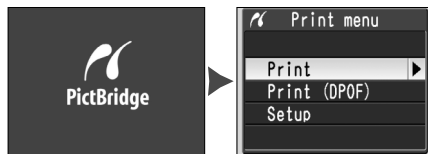

- 5 Turn the camera on. A welcome screen will be displayed in the monitor, followed by a PictBridge menu.

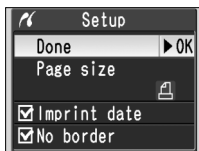

- 6 Press the multi selector up or down to highlight **Setup** and press the multi selector to the right. The menu shown at right will be displayed; press the multi selector up or down to highlight an option, then press the multi selector to the right to make the selection.



Option	Description
Done	Save changes and return to PictBridge menu.
Page size	Choose page size. Press multi selector up or down to highlight  (default size for current printer), 3.5" x 5" , 5" x 7" , Hagaki , 100 mm x 150 mm , 4" x 6" , 8" x 10" , Letter , A3 , or A4 , then press to right to select.
Imprint date	Check to print date of recording on each picture.
No border	Check to print pictures without white border (if supported; some printers will ignore this option).

- 7 To select photographs for printing or create an index print of all JPEG images on the memory card, highlight **Print** in the PictBridge menu and press the multi selector to the right ( 178–179). To print the print order created with the playback **Print set** option ( 130), highlight **Print (DPOF)** and press the multi selector to the right ( 180).

Using the Multi Selector

The multi selector can be used at any time when the monitor is on. The focus selector lock switch only takes effect when the monitor is off.

Printing Selected Photographs

To print selected photos, highlight **Print** in the PictBridge menu and press the multi selector to the right. The menu shown in Step 1 will be displayed.

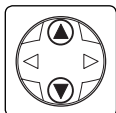
1

Highlight **Choose folder**.

2

Display list of folders.

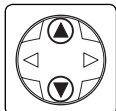
3

Highlight folder.*

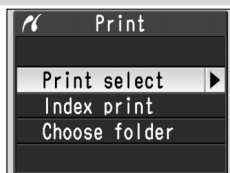
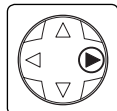
4

Return to print menu.

* To display photos in all folders, highlight **All**. To make selection from one folder only, highlight folder name.

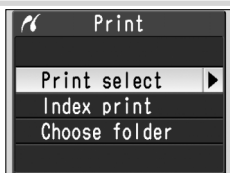
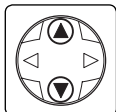
5

Highlight **Print select**.†

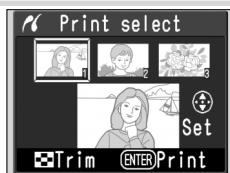
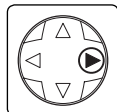
6

Display photos in current folder.

† To create index print listing all JPEG images in current folder as small thumbnail images, highlight **Index print** and press multi selector to right (do not select **Page size** when creating index prints). Photos in current folder will be displayed, with JPEG images marked by  icon. Press **ENTER** to begin printing. To interrupt printing and exit to PictBridge menu, press **ENTER** button again.

Hidden Images/RAW Images

NEF (RAW) images and images hidden with **Hide image** ( 129) can not be selected for printing using the **Print** and **Print (DPOF)** options.

7

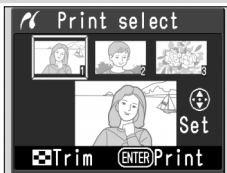

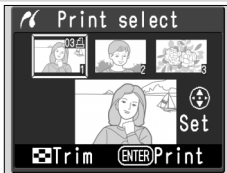

Scroll through photos. Current photo shown at bottom of display.

8



Press multi selector up to select photo and set number of prints to 1. Selected photos are marked by  icon. Press multi selector up or down to specify number of prints (up to 99).[‡]

[‡]If printer supports cropping, photo can be cropped for printing by pressing  button. Dialog shown at right will be displayed; rotate main command dial to zoom in or out and use multi selector to scroll to other areas of image (note that prints may become slightly “grainy” when highly enlarged). When desired area is framed in monitor, press  button to return to print selection dialog. Only selected portion of photo will be included when image is printed.



9

Repeat steps 7 and 8 to select additional pictures. To deselect picture, press multi selector down when number of prints is 1. To exit to Pict-Bridge menu without printing, press  button.

10



Begin printing. To cancel and return to PictBridge menu before all images have been printed, press  button again. Turn camera off and disconnect USB cable when printing is complete.

Printing the Current Print Order

To print the current print order, highlight **Print (DPOF)** in the PictBridge menu and press the multi selector to the right. This option is only available if a print order is present on the memory card.

1

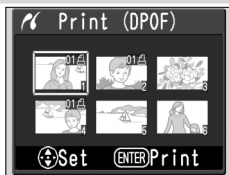

View photos in current folder. Pictures in print order are indicated by icon and number of prints; print order can be changed as described on page 131. To exit to PictBridge menu without printing, press button.

2



Begin printing. To cancel and return to PictBridge menu before all images have been printed, press button again. Turn camera off and disconnect USB cable when printing is complete.

"Data Imprint"/"Imprint Date"

Selecting **Print (DPOF)** resets the **Data imprint** and **Imprint date** options for the current print order (131). To print the date of recording on photographs, select **Imprint date** in the PictBridge **Setup** menu (177).

Error Messages

If the dialog shown at right is displayed, an error has occurred. After checking the printer and resolving any problems as directed in the printer manual, press the multi selector up or down to highlight **Continue** and press the multi selector to the right to resume printing. Select **Cancel** to exit without printing the remaining images.



Print Set (130)

To create a DPOF print order before printing, use the **Print set** option in the playback menu.

Technical Notes

Camera Care, Options, and Resources

This chapter covers the following topics:

Camera Settings

Describes the functions available in different modes.

Optional Accessories

Lists the lenses and other accessories available for the D70S.

Caring for Your Camera

Provides information on storage and maintenance.

Troubleshooting

Lists the error messages displayed by your camera and how to deal with them.

Specifications

Principal specifications for the D70S.

Camera Settings

Settings Available in Different Modes

The following table lists the settings that can be adjusted in each mode.

							P	S	A	M
Image size	✓	✓	✓	✓	✓	✓	✓	✓	✓	✓
Image quality	✓	✓	✓	✓	✓	✓	✓	✓	✓	✓
Sensitivity (ISO equivalency)	✓	✓	✓	✓	✓	✓	✓	✓	✓	✓
White balance ¹							✓	✓	✓	✓
Optimize image ¹							✓	✓	✓	✓
Shooting mode ²	✓	✓	✓	✓	✓	✓	✓	✓	✓	✓
Focus lock	✓	✓	✓	✓	✓	✓	✓	✓	✓	✓
Metering ¹							✓	✓	✓	✓
Depth-of-field preview	✓	✓	✓	✓	✓	✓	✓	✓	✓	✓ ³
Flexible program ⁴							✓			
Autoexposure lock	✓	✓	✓	✓	✓	✓	✓	✓	✓	✓
Exposure compensation ¹							✓	✓	✓	✓
Bracketing ¹							✓	✓	✓	✓
Flash sync mode ^{1, 5}	✓	✓		✓			✓	✓	✓	✓
Manual pop-up for built-in Speedlight							✓	✓	✓	✓
Auto pop-up for built-in Speedlight	✓	✓		✓			✓			
Flash exposure compensation ¹							✓	✓	✓	✓
Custom Setting 2: Autofocus ^{1, 5}	✓	✓	✓	✓	✓	✓	✓	✓	✓	✓
Custom Setting 3: AF-area mode ^{1, 5}	✓	✓	✓	✓	✓	✓	✓	✓	✓	✓
Custom Setting 4: AF assist	✓	✓		✓			✓	✓	✓	✓
Custom Setting 5: ISO auto	✓	✓	✓	✓	✓	✓	✓	✓	✓	✓
Custom Setting 19: Flash mode							✓	✓	✓	✓

1 Setting last in effect is restored next time P, S, A, or M mode is selected.

2 If self-timer, delayed remote, or quick-response remote mode is selected when camera is turned off, single-frame or continuous mode (whichever was last used) will be selected when camera is turned on.



3 CPU lens required.

4 Selecting another mode cancels flexible program.

5 Selecting , , , , , or restores default for selected mode.

Lenses for the D70S

CPU lenses (particularly type G and D lenses) are recommended for use with the D70S. IX Nikkor CPU lenses can not be used.

Camera setting Lens/accessory		Focus			Mode		Metering		
		AF	M (with electronic range finder)	M	DVP, P, S, A	M	 		
							3D	Color	
CPU lenses ¹	Type G or D AF Nikkor ² AF-S, AF-I Nikkor	✓	✓	✓	✓	✓	✓	—	✓ ³
	PC-Micro Nikkor 85 mm f/2.8D ⁴	—	✓ ⁵	✓	—	✓	✓	—	✓ ³
	AF-S/AF-I Teleconverter ⁶	✓ ⁷	✓ ⁷	✓	✓	✓	✓	—	✓ ³
	Other AF Nikkor (except lenses for F3AF)	✓ ⁸	✓ ⁸	✓	✓	✓	—	✓	✓ ³
	AI-P Nikkor	—	✓ ⁹	✓	✓	✓	—	✓	✓ ³
Non-CPU lenses ¹⁰	AI-, AI-S, or Series E Nikkor AI modified Nikkor	—	✓ ⁹	✓	—	✓ ¹¹	—	—	—
	Medical Nikkor 120 mm f/4	—	✓	✓	—	✓ ¹²	—	—	—
	Reflex Nikkor	—	—	✓	—	✓ ¹¹	—	—	—
	PC-Nikkor	—	✓ ⁵	✓	—	✓ ¹¹	—	—	—
	AI-type Teleconverter	—	✓ ⁷	✓	—	✓ ¹¹	—	—	—
	PB-6 Bellows Focusing Attachment ¹³	—	✓ ⁷	✓	—	✓ ¹¹	—	—	—
	Auto extension rings (PK-series 11-A, 12, or 13; PN-11)	—	✓ ⁷	✓	—	✓ ¹¹	—	—	—

1 IX Nikkor lenses can not be used.

2 Vibration Reduction (VR) supported with VR lenses.

3 Spot metering meters selected focus area.

4 The camera's exposure metering and flash control systems do not work properly when shifting and/or tilting the lens, or when an aperture other than the maximum aperture is used.

5 Electronic range finder can not be used with shifting or tilting.

6 Compatible with AF-I Nikkor lenses and with all AF-S lenses except DX 12–24 mm f/4G, ED 17–35 mm f/2.8D, DX 17–55 mm f/2.8G, DX ED 18–70 mm f/3.5–4.5G, ED 24–85 mm f/3.5–4.5G, VR ED 24–120 mm f/3.5–5.6G, and ED 28–70 mm f/2.8D.

7 With maximum effective aperture of f/5.6 or faster.

8 If AF 80–200 mm f/2.8S, AF 35–70 mm f/2.8S, new-model AF 28–85 mm f/3.5–4.5S, or AF 28–85 mm f/3.5–4.5S is zoomed in while focusing at minimum range, image on matte screen in viewfinder may not be in focus when in-focus indicator is displayed. Focus manually using image in viewfinder as guide.

9 With maximum aperture of f/5.6 or faster.

10 Some lenses can not be used (see following page).

11 Can be used in mode **M**, but camera exposure meter can not be used.

12 Can be used in mode **M** at shutter speeds slower than 1/125s, but camera exposure meter can not be used.

13 Attach in vertical orientation (can be used in horizontal orientation once attached).

CPU lenses can be identified by the presence of CPU contacts. Type G lenses are marked with a “G” on the lens barrel, type D lenses with a “D.”

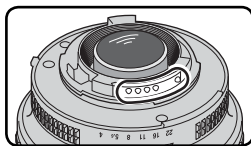

CPU lens

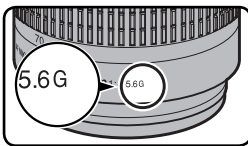

Type G lens

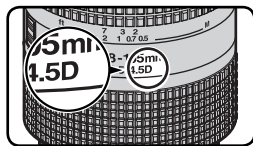

Type D lens

Type G lenses are not equipped with a lens aperture ring. Unlike other CPU lenses, there is no need to lock the aperture ring at the minimum aperture setting (maximum f -number) when using a type G lens.

❑ Incompatible Accessories and Non-CPU Lenses

The following accessories and non-CPU lenses can not be used with the D70S:

- TC-16A AF Teleconverter
- Non-AI lenses
- Lenses that require the AU-1 focusing unit (400mm $f/4.5$, 600mm $f/5.6$, 800mm $f/8$, 1200mm $f/11$)
- Fisheye (6 mm $f/5.6$, 8 mm $f/8$, OP 10 mm $f/5.6$)
- 21 mm $f/4$ (old type)
- K2 rings
- ED 180–600mm $f/8$ (serial numbers 174041–174180)
- ED 360–1200mm $f/11$ (serial numbers 174031–174127)
- 200–600mm $f/9.5$ (serial numbers 280001–300490)
- Lenses for the F3AF (80mm $f/2.8$, 200mm $f/3.5$, TC-16 Teleconverter)
- PC 28mm $f/4$ (serial number 180900 or earlier)
- PC 35mm $f/2.8$ (serial numbers 851001–906200)
- PC 35mm $f/3.5$ (old type)
- 1000mm $f/6.3$ Reflex (old type)
- 1000mm $f/11$ Reflex (serial numbers 142361–143000)
- 2000mm $f/11$ Reflex (serial numbers 200111–200310)

✎ Compatible Non-CPU Lenses

Non-CPU lenses not included in the list above can be used, but only in mode **M**. Aperture must be adjusted manually using the lens aperture ring and the camera exposure meter, depth-of-field preview, and i-TTL flash control can not be used. If another mode is selected when a non-CPU lens is attached, the shutter-release will be disabled.

Picture Angle and Focal Length

A 35-mm camera has a diagonal picture angle approximately one-and-a-half times that of the D70S. When calculating the focal length of lenses for the D70S in 35-mm format, you will therefore need to multiply the focal length of the lens by 1.5, as shown in the following table:



Picture angle	Approximate focal length (mm) in 35-mm format (modified for picture angle)							
35-mm film camera	17	20	24	28	35	50	60	85
D70S	25.5	30	36	42	52.5	75	90	127.5
35-mm film camera	105	135	180	200	300	400	500	600
D70S	157.5	202.5	270	300	450	600	750	900

Calculating Picture Angle

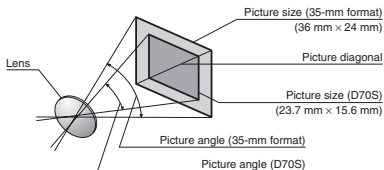
The size of the area exposed by a 35-mm camera is 36×24mm. The size of the area exposed by the D70S, in contrast, is 23.7×15.6mm. As a result, the picture angle of photographs taken with the D70S differs from the picture angle for 35-mm cameras, even when the focal length of the lens and the distance to the subject are the same.



Optional Speedlights

When used with a compatible Speedlight such as the SB-800 or SB-600 (available separately), the D70S supports many of the options available with the Nikon Creative Lighting System (CLS;  203), including i-TTL flash control ( 94), Flash Color Information Communication, and FV lock ( 103). The D70S does not support Auto FP High-Speed Sync. For more information, see the Speedlight manual.

SB-800

This high performance Speedlight has a Guide Number of 53/174 (m/ft, 35-mm zoom head position, ISO 200, 20°C/68°F; GN at ISO 100 is 38/125) and accepts four AA batteries (five AA batteries when powered by the supplied SD-800 battery pack) or SD-6, SD-7, or SD-8A power sources (available separately). The flash head can be rotated through 90° above and 7° below the horizontal, 180° left, and 90° right for bounce-flash or close-up photography. Auto power zoom (24–105 mm) ensures that the illuminating angle is adjusted in accord with lens focal length. The built-in wide panel can be used for angles of 14 mm and 17 mm. An illuminator is included to assist in adjusting settings in the dark, and custom settings are available for fine-tuning all aspects of flash operation.

SB-600

This high performance Speedlight has a Guide Number of 42/138 (m/ft, 35-mm zoom head position, ISO 200, 20°C/68°F; GN at ISO 100 is 30/98) and accepts four AA batteries (see the SB-600 manual for details). The flash head can be rotated through 90° above the horizontal, 180° left, and 90° right for bounce-flash or close-up photography. Auto power zoom (24–85 mm) ensures that the illuminating angle is adjusted in accord with lens focal length. The built-in wide panel can be used for an angle of 14 mm. An illuminator is included to assist in adjusting settings in the dark, and custom settings are available for fine-tuning all aspects of flash operation.

Use Only Nikon Flash Accessories

Use only Nikon Speedlights. Negative voltages or voltages over 250V applied to the accessory shoe could not only prevent normal operation, but damage the sync circuitry of the camera or flash. Before using a Nikon Speedlight not listed in this section, contact a Nikon-authorized service representative for more information.



The following features are available with SB-800 and SB-600 Speedlights:

Speedlight		SB-800	SB-800 (Advanced Wireless Lighting)	SB-600	SB-600 (Advanced Wireless Lighting)
i-TTL ¹		✓ ²	✓	✓ ²	✓
AA	Auto aperture ¹	✓ ³	✓	—	—
A	Non-TTL auto	✓ ³	✓ ⁴	—	—
GN	Range-priority manual	✓ ⁵	—	—	—
M	Manual	✓	✓	✓	✓
	Repeating flash	✓	—	—	—
REAR	Rear-curtain sync	✓	✓	✓	✓
	Red-eye reduction	✓	—	✓	—
Flash Color Information Communication		✓	—	✓	—
FV lock ¹		✓	✓	✓	✓
AF-assist for multi-area AF ⁶		✓	—	✓	—
Auto zoom ¹		✓	—	✓	—
ISO auto (Custom Setting 5) ¹		✓	—	✓	—

1 Available only with CPU lenses (IX Nikkor lenses excluded).

2 Standard i-TTL Flash for Digital SLR is used when spot metering is selected. Otherwise, i-TTL Balanced Fill-Flash for Digital SLR is used.

3 Use Speedlight controls to select flash mode.

4 Available only with non-CPU lenses.

5 Adjusted automatically according to camera aperture setting when CPU lens is used. When non-CPU lens is used, must be adjusted manually to match aperture selected with lens aperture ring.

6 Available with CPU AF lenses only (IX Nikkor lenses excluded).

The Accessory Shoe

The D70S is equipped with an accessory shoe that allows SB-series Speedlights, including the SB-800, 600, 80DX, 28DX, 28, 50DX, 27, 23, 22S, and 29S to be mounted directly on the camera without a sync cable. The accessory shoe is equipped with a safety lock for Speedlights with a locking pin, such as the SB-800 and SB-80DX.

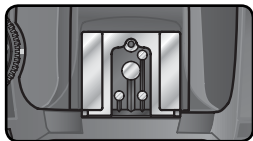

The AS-15 Accessory Shoe Adapter

An AS-15 accessory shoe adapter (available separately) can be mounted on the accessory shoe to allow flash accessories to be attached via a sync cable.



The following Speedlights can be used in non-TTL auto and manual modes. If they are set to TTL, the camera shutter-release button will lock and no photographs can be taken.







Speedlight		SB-80DX, SB-28DX, SB-28, SB-26, SB-25, SB-24	SB-50DX, SB-23, SB-29 ² , SB-21B ² , SB-29S ²	SB-30, SB-27 ¹ , SB- 22S, SB-22, SB-20, SB-16B, SB-15
A	Non-TTL auto	✓	—	✓
M	Manual	✓	✓	✓
	Repeating flash	✓	—	—
REAR	Rear-curtain sync	✓	✓	✓

1 When an SB-27 is mounted on the D70S, the flash mode is automatically set to TTL, and the shutter-release will be disabled. Set the SB-27 to A (non-TTL auto flash).

2 Autofocus is only available with AF-Micro lenses (60 mm, 105 mm, 200 mm, or 70–180 mm).

AUTO, , , , , , and Modes

When an optional Speedlight is attached in  **AUTO**, , , , , and  modes, the flash fires whenever a photograph is taken. The following flash modes are available:

- , , and  modes: Front-curtain sync and red-eye reduction. If off or auto front-curtain sync is selected when an optional Speedlight is attached, the flash sync mode selection will change to front-curtain sync. Auto with red-eye reduction becomes red-eye reduction.
- , , and  modes: Front-curtain sync is selected automatically. Red-eye reduction can also be selected.
-  mode: Slow sync, slow sync with red-eye reduction, and front-curtain sync. Auto slow sync becomes slow sync, auto slow sync with red-eye reduction becomes red-eye reduction, and off becomes front-curtain sync.

ISO Auto

When **On** is selected for Custom Setting 5 (**ISO auto**;  142), sensitivity will automatically be adjusted as required for optimal flash output. If a high sensitivity is required, this may result in the background being overexposed when the flash is used at slow shutter speeds (slow sync), fill-flash is used in bright daylight (daylight sync), or the background is brightly lit.

Using the Built-in Speedlight

The built-in Speedlight will not fire when an optional Speedlight is attached.

Notes on Optional Speedlights

Refer to the Speedlight manual for detailed instructions. If the Speedlight supports the Creative Lighting System, refer to the section on CLS-compatible digital SLR cameras. The D70S is not included in the “digital SLR” category in the SB-80DX, SB-28DX, and SB-50DX manuals.







The shutter will synchronize with an external flash at speeds of $1/500$ s or slower.

i-TTL and Auto Aperture (AA) flash control are available only with CPU lenses. Selecting spot metering while an SB-800 or SB-600 Speedlight is attached activates standard i-TTL Flash for Digital SLR.

i-TTL flash control is available at all sensitivity (ISO equivalency) settings. If the flash-ready indicator blinks for about three seconds after a photograph is taken with i-TTL flash control, the photograph may be underexposed.

When an SB-800 or SB-600 is mounted on the camera, AF-assist illumination and red-eye reduction are performed by the optional Speedlight. With other Speedlights, AF-assist illumination is performed using the AF-assist illuminator on the camera (72).

Auto power zoom is available only with SB-800 and SB-600 Speedlights.

In P, AUTO, , , , , , , and  modes, the maximum aperture (minimum f-number) is limited according to sensitivity (ISO equivalency) as shown below:

Mode	Maximum aperture at ISO equivalent of									
	200	250	320	400	500	640	800	1000	1250	1600
P, AUTO,  ,  ,  ,  ,  ,  , 	4	4.2	4.5	4.8	5	5.3	5.6	6	6.3	6.7
	8	8.5	9	9.5	10	11	11	12	13	13

For each one-step increase in sensitivity (e.g., from 200 to 400), aperture is stopped down by half an f-stop. If the maximum aperture of the lens is smaller than that listed above, the maximum value for aperture is the maximum aperture of the lens.

When an SC-series 17, 28, or 29 sync cable is used for off-camera flash photography, correct exposure may not be achieved using i-TTL Balanced Fill-Flash for Digital SLR. We recommend that you choose spot metering to select Standard i-TTL Flash for Digital SLR. Take a test shot and view the results in the monitor.

In i-TTL mode, use the flash panel provided with your Speedlight. Do not use other panels such as diffusion panels, as this may produce incorrect exposure.

Other Accessories

At the time of writing, the following accessories were available for the D70S. Contact your retailer or local Nikon representative for details.

Batteries/ Chargers/ AC adapters

- ◆ **EN-EL3a Rechargeable Li-ion Battery:** Additional EN-EL3a batteries are available from local retailers and Nikon service representatives.
- ◆ **EN-EL3 Rechargeable Li-ion Battery:** These batteries can be used with both the D100 and the D70.
- ◆ **EH-5 AC Adapter:** Use the EH-5 to power the camera for extended periods.
- ◆ **MS-D70 CR2 Holder (with Terminal Cover):** The MS-D70 can be used to power the camera with CR2 lithium batteries (Ⓢ 15), which are available at many retail outlets.
- ◆ **MH-19 Multi Charger:** The MH-19 can be used to recharge the following batteries: EN-EL3a and EN-EL3 rechargeable Li-ion batteries, MN-30 batteries for the F5 camera (with MC-E1), MN-15 batteries for the F100 camera (with MC-E2), or EN-3 batteries for the E3 camera. The charger can charge two pairs of batteries of different types, for a total of four batteries, and comes with a twelve-volt cable for connection to a cigarette-lighter socket.

Viewfinder eyepiece accessories

- ◆ **Diopter-Adjustment Viewfinder Lenses:** To accommodate individual differences in vision, viewfinder lenses are available with diopters of -5 , -4 , -3 , -2 , 0 , $+0.5$, $+1$, $+2$, and $+3 \text{ m}^{-1}$. Diopter-adjustment lenses can be inserted simply by sliding them over the viewfinder eyepiece; note that the rubber viewfinder eyepiece cup can not be used with lenses that correct for near-sightedness. Use diopter adjustment lenses only if the desired focus can not be achieved with the built-in diopter adjustment control (-1.6 to $+0.5 \text{ m}^{-1}$). Test diopter adjustment lenses before purchase to ensure that the desired focus can be achieved.
- ◆ **DG-2 Magnifier:** The DG-2 magnifies the scene displayed in the viewfinder for close-up photography, copying, telephoto lenses, and other tasks that call for added precision. Requires eyepiece adapter (available separately).
- ◆ **Eyepiece Adapter:** Use to attach the DG-2 Magnifier to the D70S.
- ◆ **DR-6 Right-Angle Viewing Attachment:** The DR-6 attaches at a right angle to the viewfinder eyepiece, allowing the image in the viewfinder to be viewed from above when the camera is in the horizontal shooting position.

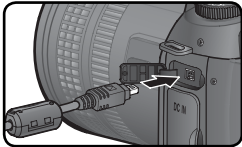

Body caps	◆ BF-1A Body Cap: The BF-1A keeps the mirror, viewfinder screen, and low-pass filter free of dust when no lens is mounted on the camera.
Remote controls and cords	◆ MC-DC1 Remote Cord: Prevents blur caused by camera shake; features a shutter-release button lock for long time-exposures. When connecting, open the remote cord connector cover and insert the MC-DC1 as shown.  ◆ ML-L3 Wireless Remote Control: The ML-L3 can be used to release the shutter remotely, without touching the camera or attaching a cable. Use for self-portraits.
Filters	<ul style="list-style-type: none">• Nikon filters can be divided into three types: screw-in, drop-in, and rear-interchange. Use Nikon filters; other filters may interfere with autofocus or electronic range finding.• The D70S can not be used with linear polarizing filters. Use the C-PL circular polarizing filter instead.• The NC and L37C filters are recommended for protecting the lens.• When using an R60 filter, set exposure compensation to +1.• To prevent moiré, use of a filter is not recommended when the subject is framed against a bright light, or when a bright light source is in the frame.• Color matrix and 3D color matrix metering may not produce the desired results when used with filters with an exposure factor (filter factor) over $1 \times$ (Y44, Y48, Y52, O56, R60, X0, X1, C-PL, ND2S, ND4S, ND4, ND8S, ND8, ND400, A2, A12, B2, B8, B12). We recommend center-weighted metering. For details, see the manual provided with the filter.
PC card adapters	◆ EC-AD1 PC Card Adapter: The EC-AD1 PC card adapter allows Type I CompactFlash memory cards to be inserted in PCMCIA card slots.
Software	◆ Nikon Capture 4 (Version 4.2 or Later): Nikon Capture 4 version 4.2 or later can be used to capture photos to a computer and to edit and save RAW images in other formats.

✔ Use Only Nikon Brand Accessories

Only Nikon brand accessories certified by Nikon specifically for use with your Nikon digital camera are engineered and proven to operate within its operational and safety requirements. THE USE OF NON-NIKON ACCESSORIES COULD DAMAGE YOUR CAMERA AND MAY VOID YOUR NIKON WARRANTY.

Approved Memory Cards

The following cards have been tested and approved for use in the D70S:

SanDisk	SDCFB	16 MB, 48 MB, 80 MB, 96 MB, 128 MB, 160 MB, 256 MB, 512 MB, 1 GB
	SDCFB (Type II)	192 MB, 300 MB
	SDCF2B (Type II)	
	SDCFH (Ultra)	128 MB, 192 MB, 256 MB, 384 MB, 512 MB, 1 GB
	SDCFH (Ultra II)	256 MB
	SDFCX	512 MB, 1 GB
Lexar Media	SDFCX (Extreme III)	1 GB, 2 GB
	4× USB	16 MB, 32 MB, 64 MB
	8× USB	16 MB, 32 MB, 48 MB, 64 MB, 80 MB
		160 MB
	12× USB	64 MB, 128 MB, 192 MB, 256 MB, 512 MB
	16× USB	192 MB, 256 MB, 320 MB, 512 MB, 640 MB, 1 GB
		256 MB, 512 MB
	24× WA USB	
	32× WA USB	1 GB
	40× WA USB	256 MB, 512 MB, 1 GB, 2 GB, 4 GB
Renesas Technology (Hitachi)	80× WA USB	512 MB, 1 GB, 2 GB, 4 GB
	HB28B C8×	16 MB, 32 MB
Microdrive	DSCM	512 MB, 1 GB
	3K4	2 GB, 4 GB

Operation is not guaranteed with other makes of card. For more details on the above cards, please contact the manufacturer.

✓ Memory Cards

- Memory cards may be hot after use. Observe due caution when removing memory cards from the camera.
- Format memory cards before first use.
- Turn the power off before inserting or removing memory cards. Do not remove memory cards from the camera, turn the camera off, or remove or disconnect the power source during formatting or while data are being recorded, deleted, or copied to a computer. Failure to observe these precautions could result in loss of data or in damage to the camera or card.
- Do not touch the card terminals with your fingers or metal objects.
- Do not apply force to the card casing. Failure to observe this precaution could damage the card.
- Do not bend, drop, or subject to strong physical shocks.
- Do not expose to heat, water, high levels of humidity, or direct sunlight.

Storage

When the camera will not be used for an extended period, replace the monitor cover, remove the battery, and store the battery in a cool, dry area with the terminal cover in place. To prevent mold or mildew, store the camera in a dry, well-ventilated area. Do not store your camera with naphtha or camphor moth balls or in locations that:

- are poorly ventilated or subject to humidities of over 60%
- are next to equipment that produces strong electromagnetic fields, such as televisions or radios
- are exposed to temperatures above 50°C/122°F (for example, near a space heater or in a closed vehicle on a hot day) or below -10°C (14°F)

Cleaning

Camera body	Use a blower to remove dust, dirt, or sand then wipe gently with a soft, dry cloth. After using the camera at the beach or seaside, wipe off any sand or salt with a dry cloth lightly dampened with fresh water, then dry thoroughly. The camera may be damaged if foreign matter gets inside the camera body. Nikon cannot accept liability for damage caused by dirt or sand.
Lens, mirror, and viewfinder	These elements are made of glass and are easily damaged. Remove dust and lint with a blower. If using an aerosol blower, keep the can vertical to prevent the discharge of liquid. To remove fingerprints and other stains, apply a small amount of lens cleaner to a soft cloth and clean with care.
Monitor	Remove dust and lint with a blower. When removing fingerprints and other stains, wipe the surface lightly with a soft cloth or chamois leather. Do not apply pressure, as this could result in damage or malfunction.

The Monitor

Should the monitor break, care should be taken to avoid injury caused by broken glass and to prevent liquid crystal from entering your eyes and mouth.

The Control Panel

Rarely, static electricity may cause the control panel to brighten or darken. This does not indicate a malfunction; the display will shortly return to normal.



The Low-Pass Filter

The CCD image sensor that acts as the camera's picture element is fitted with a low-pass filter to prevent moiré. Although this filter prevents foreign objects from adhering directly to the image sensor, under certain conditions dirt or dust on the filter may appear in photographs. If you suspect that dirt or dust inside the camera is affecting your photographs, you can check for the presence of foreign objects on the low-pass filter as described below.

- 1 Remove the lens and turn the camera on.
- 2 Press the **MENU** button and select **Mirror lock-up** from the setup menu (162). Highlight **Yes** and press the multi-selector to the right. The message, "Press shutter-release button" will be displayed in the camera monitor, and a row of dashes will be displayed in the control panel and viewfinder.
- 3 Press the shutter-release button all the way down. The mirror will be raised and the shutter curtain will open, revealing the low-pass filter, and the row of dashes in the control panel will blink.
- 4 Holding the camera so that light falls on the low-pass filter, examine the filter for dust or lint. If there are foreign objects on the filter, the filter requires cleaning. See the following section.

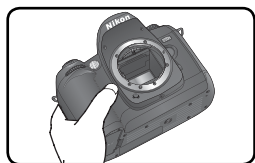
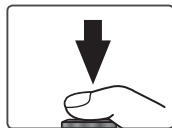

- 5 Turn the camera off. The mirror will return to the down position and the shutter curtain will close. Replace the lens or body cap and disconnect the AC adapter.

Cleaning the Low-Pass Filter

The low-pass filter is extremely delicate and easily damaged. Nikon recommends that filter be cleaned only by Nikon-authorized service personnel. Should you choose to clean the filter yourself, follow the steps below.

- 1 Raise the mirror as described in steps 1–4 on the preceding page.

- 2 Remove dust and lint from the filter with a blower. Do not use a blower-brush, as the bristles could damage the filter. Dirt that can not be removed with a blower can only be removed by Nikon-authorized service personnel. Under no circumstances should you touch or wipe the filter.

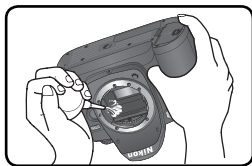

- 3 Turn the camera off. The mirror will return to the down position and the shutter curtain will close. Replace the lens or body cap.

Servicing the Camera and Accessories

The D70S is a precision device and requires regular servicing. Nikon recommends that the camera be inspected by the original retailer or Nikon service representative once every one to two years, and that it be serviced once every three to five years (note that fees apply to these services). Frequent inspection and servicing are particularly recommended if the camera is used professionally. Any accessories regularly used with the camera, such as lenses or optional Speedlights, should be included when the camera is inspected or serviced.

Use an AC Adapter

To prevent the camera from powering off while the mirror is raised, use an EH-5 AC adapter (available separately) for prolonged inspection or cleaning of the low-pass filter.

Caring for the Camera and Battery: Cautions

Do not drop

The product may malfunction if subjected to strong shocks or vibration.

Keep dry

This product is not waterproof, and may malfunction if immersed in water or exposed to high levels of humidity. Rusting of the internal mechanism can cause irreparable damage.

Avoid sudden changes in temperature

Sudden changes in temperature, such as occur when entering or leaving a heated building on a cold day, can cause condensation inside the device. To prevent condensation, place the device in a carrying case or a plastic bag before exposing it to sudden changes in temperature.

Keep away from strong magnetic fields

Do not use or store this device in the vicinity of equipment that generates strong electromagnetic radiation or magnetic fields. Strong static charges or the magnetic fields produced by equipment such as radio transmitters could interfere with the monitor, damage data stored on the memory card, or affect the product's internal circuitry.

Do not leave the lens pointed at the sun

Do not leave the lens pointed at the sun or another sight source for an extended period. Intense light may cause the image sensor to deteriorate or produce a white blur effect in photographs.

Blooming

Vertical white streaks may appear in photographs of the sun or other strong light sources. This phenomenon, known as "blooming," can be prevented by reducing the amount of light that falls on the CCD, either by choosing a slow shutter speed and small aperture or by using an ND filter.

Do not touch the shutter curtain

The shutter curtain is extremely thin and easily damaged. Under no circumstances should you exert pressure on the curtain, poke it with cleaning tools, or subject it to powerful air currents from a blower. These actions could scratch, deform, or tear the curtain.

Handle all moving parts with care

Do not apply force to the battery-chamber, card-slot, or connector covers. These parts are especially susceptible to damage.

Cleaning

- When cleaning the camera body, use a blower to remove dust and lint, then wipe gently with a soft, dry cloth. After using your camera at the beach or seaside, wipe off any sand or salt using a cloth lightly dampened with pure water and then dry your camera thoroughly. In rare instances, static electricity produced by a brush or cloth may cause the LCD displays to light up or darken. This does not indicate a malfunction, and the display will shortly return to normal.
- When cleaning the lens and mirror, remember that these elements are easily damaged. Dust and lint should be gently removed with a blower. When using an aerosol blower, keep the can vertical (tilting the can could result in liquid being sprayed on the mirror). If you do get a fingerprint or other stain on the lens, apply a small amount of lens cleaner to a soft cloth and wipe the lens carefully.
- See "Cleaning the Low-Pass Filter" for information on cleaning the low-pass filter (B 194).

Storage

- To prevent mold or mildew, store the camera in a dry, well-ventilated area. If you will



not be using the product for long periods, remove the battery to prevent leakage and store the camera in a plastic bag containing a desiccant. Do not, however, store the camera case in a plastic bag, as this may cause the material to deteriorate. Note that desiccant gradually loses its capacity to absorb moisture and should be replaced at regular intervals.

- Do not store the camera with naphtha or camphor moth balls, close to equipment that produces strong magnetic fields, or in areas subject to extremes of temperature, for example near a space heater or in a closed vehicle on a hot day.
- To prevent mold or mildew, take the camera out of storage at least once a month. Turn the camera on and release the shutter a few times before putting the camera away again.
- Store the battery in a cool, dry place. Replace the terminal cover before putting the battery away.

Notes on the monitor

- The monitor may contain a few pixels that are always lit or that do not light. This is a characteristic common to all TFT LCD monitors and does not indicate a malfunction. Images recorded with the product will not be affected.
- Images in the monitor may be difficult to see in a bright light.
- Do not apply pressure to the monitor; this could cause damage or malfunction. Dust or lint on the monitor can be removed with a blower. Stains can be removed by rubbing the surface lightly with a soft cloth or chamois leather.
- Should the monitor break, care should be taken to avoid injury due to broken glass and to prevent the liquid crystal from the monitor touching the skin or entering the eyes or mouth.
- Replace the monitor cover when transporting the camera or leaving it unattended.

Turn the product off before removing or disconnecting the power source

Do not unplug the product or remove the battery while the product is on, or while images are being recorded or deleted. Forcibly cutting power to the product in these circumstances could result in loss of data or in damage to product memory or internal circuitry. To prevent an accidental interruption of power, avoid carrying the product from one location to another while the AC adapter is connected.

Batteries







- When you turn the device on, check the battery-level displayed in the control panel to determine whether the battery needs to be recharged or replaced. The battery needs to be recharged or replaced when the battery-level indicator is flashing.
- When taking photographs on important occasions, ready a spare EN-EL3a battery and keep it fully charged, or keep a set of three fresh CR2 batteries on hand in the optional MS-D70 battery holder (🔋 15). Depending on your location, you may find it difficult to purchase replacement batteries on short notice.
- On cold days, the capacity of batteries tends to decrease. Be sure the battery is fully charged before taking photographs outside in cold weather. Keep a spare battery in a warm place and exchange the two as necessary. Once warmed, a cold battery may recover some of its charge.
- Should the battery terminals become dirty, wipe them off with a clean, dry cloth before use.
- After removing the battery from the camera, be sure to replace the terminal cover.
- Used batteries are a valuable resource. Please recycle used batteries in accord with local regulations.

Troubleshooting



Understanding Error Messages and Displays

This section lists the indicators and error messages that appear in the viewfinder, control panel, and monitor when there is a problem with the camera. Consult the list below before contacting your retailer or Nikon representative.

Indicator		Problem	Solution	8
Control panel	Viewfinder			
		Low battery.	Ready a fully-charged spare battery.	14
(blinks)	(blinks)	Battery exhausted.	Replace battery.	14
FE E (blinks)		Lens aperture ring is not set to minimum aperture.	Set ring to minimum aperture (largest f/-number).	18
F - - (blinks)		No lens attached, or non-CPU lens attached.	Attach CPU lens (IX Nikkor excluded), or rotate mode dial to M and use lens aperture ring to set aperture.	18, 82
	● (blinks)	Camera unable to focus using autofocus.	Focus manually.	74
H I		Subject too bright; photo will be overexposed.	<ul style="list-style-type: none"> • If sensitivity (ISO equivalency) is over 200, lower sensitivity. • Use ND filter • In mode: <ul style="list-style-type: none"> S Increase shutter speed A Choose a smaller aperture (larger f/-number) 	46 191 79 81
L o		Subject too dark; photo will be underexposed.	<ul style="list-style-type: none"> • If sensitivity (ISO equivalency) is under 1600, raise sensitivity. • Use built-in Speedlight. • In mode: <ul style="list-style-type: none"> S Lower shutter speed A Choose a larger aperture (smaller f/-number) 	46 94 79 81
bulb (blinks)	bulb	bulb selected in mode S .	Change shutter speed or select mode M .	79, 82

Indicator		Problem	Solution	
Control panel	Viewfinder			
- - (blinks)		- - selected in remote control mode and mode dial rotated to S .	Change shutter speed or select mode M .	79, 82
	 (blinks)	<ul style="list-style-type: none"> Flash required for correct exposure (P, S, A, M modes). Flash has fired at full power ( blinks for three seconds after flash fires) . 	<ul style="list-style-type: none"> Raise built-in Speedlight. Check photo in monitor; if underexposed, adjust settings and try again. 	97 114
 (blinks)		Speedlight that does not support i-TTL flash control attached and set to TTL.	Change flash mode setting on optional Speedlight.	186
FULL  (blinks)	FULL  (blinks)	Memory insufficient to record further photos at current settings, or camera has run out of file or folder numbers.	<ul style="list-style-type: none"> Reduce quality or size. Delete photographs. Insert new memory card. 	41 124 20
Err (blinks)		Camera malfunction.	Release shutter. If error persists or appears frequently, consult with Nikon-authorized service representative.	2

Indicator		Problem	Solution	
Monitor	Control panel			
NO CARD PRESENT	-E-	Camera cannot detect memory card.	Turn camera off and confirm that card is correctly inserted.	20
CARD IS NOT FORMATTED	For	Memory card has not been formatted for use in D70S.	Format memory card.	21

Indicator		Problem	Solution	
Monitor	Control panel			
THIS CARD CANNOT BE USED	 (blinks)	<ul style="list-style-type: none"> • Error accessing memory card. • Unable to create new folder • Card has not been formatted for use in D70S. 	<ul style="list-style-type: none"> • Use Nikon-approved card. • Check that contacts are clean. If card is damaged, contact retailer or Nikon representative. • Delete files or insert new memory card. • Format memory card. 	192 2, 20 20, 24 21
FOLDER CONTAINS NO IMAGES		<ul style="list-style-type: none"> • Memory card contains no images. • Current folder is empty. 	<ul style="list-style-type: none"> • Insert another card. • Set Playback fldr to All. 	20 126
ALL IMAGES HIDDEN		All photos in current folder are hidden.	Set Playback fldr to All or use Hide image to reveal hidden photos.	126, 129
FILE DOES NOT CONTAIN IMAGE DATA		File has been created or modified using a computer or different make of camera, or file is corrupt.	Delete file or reformat memory card.	21, 124

A Note on Electronically-Controlled Cameras

In extremely rare instances, unusual characters may appear in the control panel and the camera may stop functioning. In most cases, this phenomenon is caused by a strong external static charge. Turn the camera off, remove and replace the battery, and turn the camera on again, or, if you are using an AC adapter (available separately), disconnect and reconnect the adapter and turn the camera on again. If the problem persists, press the reset switch (see right) and then reset the camera clock to the correct date and time ( 16). In the event of continued malfunction, contact your retailer or Nikon representative. Note that disconnecting the power source as described above may result in loss of any data not recorded to the memory card at the time the problem occurred. Data already recorded to the card will not be affected.

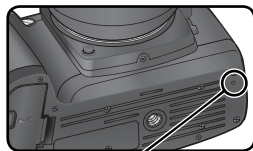

Reset switch

Specifications



Type	Single-lens reflex digital camera with interchangeable lenses
Effective pixels	6.1 million
CCD	23.7 × 15.6 mm; total pixels: 6.24 million
Image size (pixels)	<ul style="list-style-type: none"> • 3008 × 2000 (Large) • 2240 × 1488 (Medium) • 1504 × 1000 (Small)
Lens mount	Nikon F mount (with AF coupling and AF contacts)
Compatible lenses*	
Type G or D AF Nikkor	All functions supported
Micro Nikkor 85 mm f/2.8D	All functions supported except autofocus and some exposure modes
Other AF Nikkor†	All functions supported except 3D color matrix metering and i-TTL Balanced Fill-Flash for Digital SLR
AI-P Nikkor	All functions supported except 3D color matrix metering, i-TTL Balanced Fill-Flash for Digital SLR, and autofocus
Non-CPU	Can be used in mode M , but exposure meter does not function; electronic range finder can be used if maximum aperture is f/5.6 or faster
* IX Nikkor lenses can not be used † Excluding lenses for F3AF	
Picture angle	Equivalent in 35-mm format is approximately 1.5 times lens focal length
Viewfinder	Fixed-eyelevel penta-Dach-mirror type
Diopter adjustment	-1.6–+0.5 m ⁻¹
Eyepoint	18 mm (-1.0 m ⁻¹)
Focusing screen	Type B BriteView clear matte screen Mark V with superimposed focus brackets and On-Demand grid lines
Frame coverage	Approximately 95% of lens (vertical and horizontal)
Magnification	Approximately 0.75× (50-mm lens at infinity; -1.0 m ⁻¹)
Reflex mirror	Quick return
Lens aperture	Instant return with depth-of-field preview
Focus-area selection	Can be selected from 5 focus areas
Lens servo	<ul style="list-style-type: none"> • Autofocus (AF): Instant single-servo AF (AF-S); continuous-servo AF (AF-C); predictive focus tracking automatically activated according to subject status • Manual focus (M)



Autofocus	TTL phase detection by Nikon Multi-CAM900 autofocus module with AF-assist illuminator (range approximately 0.5–3.0m/1'8"–9'10")
Detection range	–1 – +19EV (ISO 100 at 20°C/68°F)
AF-area mode	Single-area AF, dynamic-area AF, dynamic-area AF with closest subject priority
Focus lock	Focus can be locked by pressing shutter-release button half-way (single-servo AF) or by pressing AE-L/AF-L button
Exposure	
Metering	Three-mode through-the-lens (TTL) exposure metering
Matrix	3D color matrix metering (type G and D lenses); color matrix metering (other CPU lenses); metering performed by 1,005-pixel RGB sensor
Center-weighted	Weight of 75% given to 6, 8, 10, or 12-mm circle in center of frame
Spot	Meters 2.3-mm circle (about 1% of frame) centered on active focus area
Range (ISO 100 equivalent, f/1.4 lens, 20 °C/68 °F)	0–20EV (3D color matrix or center-weighted metering) 2–20EV (spot metering)
Exposure meter coupling	CPU coupling
Exposure control	
Operating mode	Digital Vari-Program (📷 auto, 📷 portrait, 📷 landscape, 📷 close up, 📷 sports, 📷 night landscape, 📷 night portrait), programmed auto (P) with flexible program; shutter-priority auto (S); aperture priority auto (A); manual (M)
Exposure compensation	–5 – +5EV in increments of 1/3 or 1/2EV
Bracketing	Exposure and/or flash bracketing (2–3 exposures in increments of 1/3 or 1/2EV)
Exposure lock	Luminosity locked at detected value with AE-L/AF-L button
Shutter	
Speed	30 – 1/8000 s in steps of 1/3 or 1/2EV, bulb, remote
Sensitivity	200 – 1600 (ISO equivalent) in steps of 1/3EV
White balance	Auto (TTL white-balance with 1,005 pixels RGB sensor), six manual modes with fine-tuning, preset white balance
Bracketing	2–3 exposures in increments of 1

Built-in Speedlight	<ul style="list-style-type: none"> • : auto flash with auto pop-up • P, S, A, M: manual pop-up with button release
Guide number (m/ft at 20 °C/68 °F)	<ul style="list-style-type: none"> • ISO 200: approximately 15/49 (manual 17/56) • ISO 100: approximately 11/36 (manual 12/39)
Flash	
Sync contact	X-contact only; flash synchronization at up to 1/500 s
Flash control	
TTL	TTL flash control by 1,005-pixel RGB sensor (CPU lenses only) <ul style="list-style-type: none"> • Built-in Speedlight: i-TTL balanced fill-flash for digital SLR, or standard i-TTL flash for digital SLR (spot metering or mode dial set to M) • SB-800 or 600: i-TTL balanced fill-flash for digital SLR, or standard i-TTL flash for digital SLR (spot metering)
Auto aperture	Available with SB-800 with CPU lens
Non-TTL auto	Available with such Speedlights as SB-800, 80DX, 28DX, 28, 27, and 22s
Range-priority manual	Available with SB-800
Sync modes	<ul style="list-style-type: none"> • : front curtain sync, red-eye reduction • : slow sync, slow sync with red-eye reduction • : front curtain sync and red-eye reduction available with optional Speedlights • P, S, A, M: front curtain sync, slow sync, rear-curtain sync, red-eye reduction, slow sync with red-eye reduction
Flash compensation	-3 – +1 EV in increments of 1/3 or 1/2 EV
Flash-ready indicator	Lights when SB-series Speedlight such as 800, 600, 80DX, 28DX, 50DX, 28, 27, or 22s is fully charged; blinks for 3s after flash is fired at full output
Accessory shoe	Standard ISO hot-shoe contact with safety lock
Creative Lighting System	Supports Flash Color Information Communication and FV lock with built-in Speedlight, SB-800, and SB-600. SB-800 and 600 also support Advanced Wireless Lighting.
Storage	
Media	Type I and II CompactFlash memory cards; Microdrives
File system	Compliant with Design Rule for Camera File System (DCF) 2.0 and Digital Print Order Format (DPOF)
Compression	<ul style="list-style-type: none"> • NEF (RAW): compressed 12-bit • JPEG: JPEG baseline-compliant

Self-timer	Electronically controlled timer with 2–20s duration
Depth-of-field preview	When CPU lens is attached, lens aperture can be stopped down to value selected by user (A and M modes) or value selected by camera (Digital Vari-Program, P , and S modes)
Monitor	2.0", 130,000-dot, low-temperature polysilicon TFT LCD with brightness adjustment
Video output	Can be selected from NTSC and PAL
External interface	USB 2.0 full speed
Tripod socket	1/4" (ISO)
Firmware upgrades	Firmware can be upgraded by user
Supported languages	Chinese (Simplified), Dutch, English, French, German, Italian, Japanese, Korean, Spanish, Swedish
Power source	<ul style="list-style-type: none"> • One rechargeable Nikon EN-EL3a or EN-EL3 Li-ion battery; charging voltage (MH-18a quick charger or optional MH-18 quick charger or MH-19 multi charger): 7.4V DC • Three CR2 lithium batteries (with optional MS-D70 battery holder;  15) • EH-5 AC adapter (available separately)
Dimensions (W × H × D)	Approximately 140 × 111 × 78 mm (5.5" × 4.4" × 3.1")
Weight	Approximately 600g (1 lb 5 oz) without battery, memory card, body cap, or monitor cover
Operating environment	
Temperature	0–40°C (32–104°F)
Humidity	Less than 85% (no condensation)

- Unless otherwise stated, all figures are for a camera with a fully-charged battery operating at an ambient temperature of 20°C (68°F).
- Nikon reserves the right to change the specifications of the hardware and software described this manual at any time and without prior notice. Nikon will not be held liable for damages that may result from any mistakes that this manual may contain.

Battery Life

The number of shots that can be taken with a fully-charged EN-EL3a battery (1500 mAh) varies with the condition of the batteries, temperature, and how the camera is used. The following measurements were performed at a temperature of 20°C (68°F).

Example 1: 2500 shots

Zoom Nikkor AF-S DX 18–70mm f/3.5–4.5G IF ED lens; continuous shooting mode; continuous-servo autofocus; image quality set to JPEG Basic; image size set to **M**; shutter speed $\frac{1}{250}$ s; shutter-release pressed halfway for three seconds and focus cycled from infinity to minimum range three times with each shot; after six shots, monitor turned on for five seconds and then turned off; cycle repeated once exposure meters have turned off.

Example 2: 500 shots

AF-S DX 18–70mm f/3.5–4.5G IF ED lens; single-frame shooting mode; single-servo autofocus; image quality set to JPEG Normal; image size set to **L**; shutter speed $\frac{1}{250}$ s; shutter-release pressed halfway for five seconds and focus cycled from infinity to minimum range once with each shot; built-in Speedlight fired at full power with every other shot; AF-assist illuminator lights when Speedlight is used; cycle repeated once exposure meters have turned off; camera turned off for one minute with every ten shots.

The following can reduce battery life:

- Using the monitor
- Repeated autofocus operations
- Keeping the shutter-release button pressed halfway
- Taking NEF (RAW) photographs
- Slow shutter speeds

To ensure maximum battery performance:







- Keep the battery contacts clean. Soiled contacts can reduce battery performance.
- Use EN-EL3a batteries immediately after charging. Batteries will lose their charge if left unused.

Menus

- ▶ Playback menu, 124–131
 - Delete, 124–125
 - Playback fldr, 126
 - Rotate tall, 126
 - Slide show, 127–128
 - Hide image, 129
 - Print set, 130–131
- 📷 Shooting menu, 132–134
 - Optimize image, 56–61
 - Long exp. NR, 133
 - Image quality, 41–42
 - Image size, 43–45
 - White bal., 48–55
 - ISO, 46–47
- 🔧 CSM menu, 135–154
 - R Menu reset, 136–137
 - 01 Beep, 138
 - 02 Autofocus, 139
 - 03 AF-area mode, 140
 - 04 AF assist, 141
 - 05 ISO auto, 142–143
 - 06 No CF Card?, 143
 - 07 Image review, 144
 - 08 Grid display, 144
 - 09 EV step, 144
 - 10 Exp comp., 145
 - 11 Center wtd, 145
 - 12 BKT set, 146
 - 13 BKT Order, 146
 - 14 Command dial, 147
 - 15 AE-L/AF-L, 147
 - 16 AE Lock, 148
 - 17 Focus area, 148
 - 18 AF area illum, 149
 - 19 Flash mode, 150–151
 - 20 Flash sign, 152
 - 21 Shutter spd, 152
 - 22 Monitor off, 153
 - 23 Meter-off, 153
 - 24 Self-timer, 153
 - 25 Remote, 154
- ⚡ Setup menu, 155–168
 - Folders, 156–158
 - File No. Seq., 159
 - Format, 160
 - CSM menu, 161

- Date, 16, 161
- LCD brightness, 161
- Mirror lock-up, 162
- Video mode, 162
- Language, 16, 163
- Image comment, 163–164
- USB, 165, 171, 176
- Dust ref photo, 166–167
- Firmware Ver., 167
- Image rotation, 168

Symbols

      See mode, Digital Vari-Program
3D color matrix metering. See metering

A

- A. See mode
- Advanced Wireless Lighting, 187
- AF. See focus mode; auto-focus
- AF-area mode, 140
- AF-assist illuminator, 72
- Aperture, 76–83
-  (auto) mode, 32
- Auto meter off, 12
- Autoexposure lock, 84
- Autofocus, 64, 139
 - AF-C, 139
 - AF-S, 139

B

- Backlight, control panel, 7
- BASIC. See  Shooting menu, Image quality
- Battery, 14–15
 - CR2, 14
 - EN-EL3a, 14
 - inserting, 14–15
 - life, 205
 - storage, 196–197
- BKT. See bracketing
- Blur, reducing, 80
- Bracketing, 87–93. See also Exposure bracketing; white balance, bracketing
- Brightness. See **⚡ Setup menu, LCD Brightness**
- Bulb. See long time exposures

C

- CCD, 201
 - cleaning, 194–195
- Clock, 16–17
- Closest subject priority. See AF-area mode
- Color mode**, 59
- Color profile. See **Color mode**
- Color temperature. See white balance
- CompactFlash. See memory card
- Computer, 171–174
- Continuous shooting. See shooting mode
- Contrast. See **Tone comp.**
- CPU lenses, 183–184
- Creative Lighting System, 186–189
- Custom Settings, 135–154
 - defaults, 136–137
- CSM. See Custom Settings

D

- Date. See **⚡ Setup menu, Date**
- Deleting, 122. See also memory card, formatting
 - all images, 125
 - selected images, 125
 - single-frame playback, 31
- Depth-of-field preview, 76
- Digital Print Order Format, 130–131
- Digital Vari-Program. See  mode
- Diopter, 27
- DPOF. See Digital Print Order Format
- DVP. See mode, Digital Vari-Program
- Dynamic-area AF. See AF-area mode.

E

- Electronic analog exposure display, 82–83
- Electronic range finder, 74

EV step, 144
 Exif version 2.21, 130
 Exposure bracketing, 88–91
 Exposure compensation, 86
 Exposure meters, 75. *See also*
 auto meter off
 Eyepiece cap, 105, 108

F
 FAT32, 160
 Files. *See* image files
 FINE. *See*  **Shooting menu, Image quality**
 Firmware, 167
 Flash, 94–104, 186–189. *See also* Speedlight
 bracketing, 87–91
 Flash Color Information Communication, 48, 186–187
 Flash exposure compensation, 102
 Flash-ready indicator, 94, 97
 Flash mode, 150–151
 Flash sync mode, 95–96
 Flexible program, 77. *See also*
 mode, **P, S, A, M**
 Focal plane mark, 74
 Focus. *See* autofocus; focus
 mode; manual focus
 Focus area (focus brackets), 66
 Focus lock, 70
 Focus mode, 64
 Focusing screen, 8
 Folders, 126, 156–158
 FV lock, 103–104

G
 Grid display, 144

H
 Hiding images. *See*  **Playback menu, Hide image**
 Highlight display, 116
 Histogram, 116
Hue adjustment, 60

I
 Illuminator. *See* backlight,
 control panel
 Image dust off, 166–167

Image files, 41
 Image review, 144
ISO, 134. *See also* Sensitivity
 ISO auto, 142–143
 i-TTL flash control, 94

J
 JPEG, 41–45

L
L. *See*  **Shooting menu, Image size**
 Language. *See* **Y Setup menu, Language**
Language
 Lens, 183–185
 attaching, 18–19
 compatible, 183–184
 CPU, 183–184
 non-CPU, 183–184
 type G or D, 183–184
 Long time-exposures, 82–83
 Low-pass filter, 194–195

M
M. *See*  **Shooting menu, Image size**; manual focus;
 mode
 Manual focus, 74
Mass storage, 165
 Memory buffer, 62–63
 Memory card, 20–21
 approved, 192
 capacity of, 45
 formatting, 21
 Metering, 75
 Microdrive. *See* memory card
 Mode, 10–11
 Digital Vari-Program, 32–34
P, S, A, M, 77–83
 Monitor, 193
 auto off, 153
 cover, 13
 Monitor pre-flashes, 94

N
 NEF, 41–45. *See also*  **Shooting menu, Image quality**; RAW

Nikon Capture 4, 41, 59,
 163, 165, 166, 168, 171,
 173, 191

Noise, 83
 reduction, 133
 NORMAL. *See*  **Shooting menu, Image quality**



O
 On-Demand grid lines. *See*
 Grid display.

P
P. *See* mode
 PictBridge, 175–180
 PictureProject, 41, 59, 163,
 165, 168, 171, 173
 Picture Transfer Protocol. *See*
PTP
 Photo information, 116–117
 Playback, 113–122
 Playback menu, 124–131
 PRE. *See* White balance,
 preset
 Predictive focus tracking, 65
 Printing photographs,
 175–180
 Protecting images, 121
PTP, 165

R
 RAW, 41–45. *See also*  **Shooting menu, Image quality**;
 NEF
 Red-eye reduction, 95–96
 Remote control, 107–110.
See also shooting mode
 Remote cord, 191

S
S. *See*  **Shooting menu, Image size**; mode
Saturation, 60
 Self-portraits. *See* remote
 control; self-timer
 Self-timer, 105–106. *See also*
 shooting mode
 Sensitivity, 46–47. *See also* **ISO**
 Setup menu, 155–168
Sharpening, 57



- Shutter speed, 76–83
 - and flash synchronization, 99
- Shooting menu, 132–134
- Shooting mode, 62–63
- Single-area AF. See AF-area mode.
- Single-frame playback, 114–115
- Single-frame shooting. See Shooting mode
- Size. See  **Shooting menu, Image size**
- Slide shows. See  **Playback menu, Slide show**
- Speedlight, 94–104, 186–189.
 - See *also* flash
 - built-in, 94–104
 - optional, 186–189
- sRGB. See **Color mode**
- T**
- Television, 170
- Time. See **Y Setup menu, Date**
- Time exposures. See Long time-exposures
- Thumbnail playback, 118–119
- Tone comp.**, 58
- Two-button reset, 111
- U**
- USB. See **Y Setup menu, USB**
- V**
- Vari-brite focus areas, 8
- Video device, 162, 170
- VIDEO OUT, 170
- Viewfinder, 8–9
 - focus. See diopter
- W**
- White balance, 48–55
 - bracketing, 92–93
 - fine-tuning, 50–51
 - preset, 52–55

Nikon

No reproduction in any form of this manual, in whole or in part (except for brief quotation in critical articles or reviews), may be made without written authorization from NIKON CORPORATION.

NIKON CORPORATION

Fuji Bldg., 2-3 Marunouchi 3-chome,
Chiyoda-ku, Tokyo 100-8331, Japan

SB5B04200101(11)

6MBA2811--